

NOTBELEUCHTUNG

Gesamtkatalog 2022



SOFORT AB LAGER LIEFERBAR

5 JAHRE GARANTIE

Unsere Firma ist offizieller Partner von:

NORMALUX
by Normagrup



New products

10 Autotest 12 Normalink 13

Emergency lighting



Via R Recessed 18



Via S Surface 24



Via W Wall 34



Dunna 40



Stylo 50



GS 54



Hermetic 58



Hermetic EX 62



Smart 64

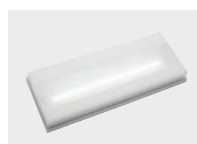

Extraplana 68

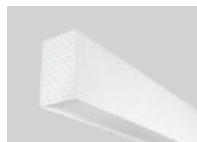

Lissa emergency light 74



Bessel 78



Volutta 80



Volutta doble 84

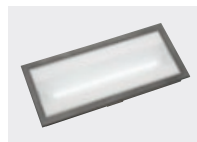

Volutta recessed mounting 88



Excellence 92



Europrisma 96



Uro 102



Hermetic XL 104



Aura 106



Aura 65 107



Watertight self-contained fittings 110



Dopplo 112



Twin spots 116



Explosion proof 118

Exit signs



Lissa exit signs 122



Extraline 126



Steeled 130



Signal 7 132

Step lighting



Central Battery Systems



Emergency lights for elevators

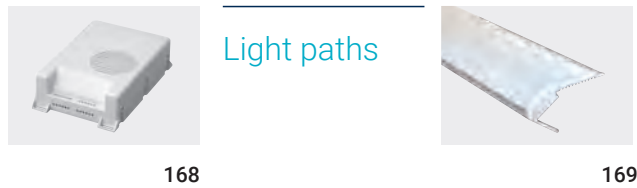

Control System



Surface covered with 1 lux

170

190

LEGEND / ICONOGRAPHY

Class	Installation	Light range	Versions	Batteries	Power	Norms / Regulation
Class I Class II Class III European Union Glow wire 850°C test LED lamp	Ceiling surface mounted Electrified rail Ceiling surface mounted lamelas Recessed in the ceiling Ceiling suspended mounted Wall surface mounted Recessed in the wall	Lm XXX-XXX Autonomy X Modes of operation Maintained No Maintained Maintained / No Maintained	Autotest DALI Intelligent Wireless Central Battery System SATI SATI addressable	Ni-Cd Ni-Cd / Ni-MH Lithium Lead IP IK IP XX IK XX	24 Vdc 230 Vac Low temperatures -25°C Quick assembly plug in system 	EN XXXXX Maximum viewing distance XX m

New products

RESTYLING

Dunna

The Dunna range has earned your trust for more than half a century and now it has been renewed to provide you with an even easier installation and an extra 20% luminic efficiency.



STANDARD | AUTOTEST | 

CENTRAL BATTERY SYSTEM

And with the new accessories, new possibilities are available.

NEW ACCESSORY

IP 67 

GS

New IP67 IK10 box for the GS family.

POWER SUPPLY MODULE

MA24-6

Power supply module for 24v step lights to be mounted on DIN rail.



CONTINUITY KIT

Kira Led



NORMALINK

Intelligent Wireless

Now Normalink is compatible with Intelligent Wireless emergency lighting units from Normalux.

Normalux ranges with Intelligent Wireless option:

● VIA R

● VIA R waterproof IP65

● EXCELLENCE

● EUROPRISMA

● EXTRALINE



New products

NEW SOLUTIONS

Vía

VIA range grows up keeping its essence of an emergency light with design and high luminic efficiency. Now with new versions available to cover the needs of any project.

Vía R Recessed

Recessed
IP40



Recessed
waterproof IP65



Vía S Surface

Surface
mounting



Electrified
track
mounting



For stave
ceiling



N
New

Ceiling
surface
mounting



N
New

Ceiling
suspended
mounting



N
New

Vía W Wall

Wall



Outdoors wall mounted



N
New

Cylindrical wall mounted



N
New



Emergency lighting

Via R Recessed	18
Via S Surface	24
Via W Wall	34
Dunna	40
Stylo	50
GS	54
Hermetic	58
Hermetic EX	62
Smart	64
Extraplana	68
Lissa emergency light	74
Bessel	78
Volutta	80
Volutta doble	84
Volutta recessed mounting	88
Excellence	92
Europrisma	96
Uro	102
Hermetic XL	104
Aura	106
Aura 65	107
Watertight self-contained fittings	110
Dopplo	112
Twin spots	116
Explosion proof	118

Via

Much more than just design

Via Led has turned into the definitive emergency luminaire by bringing together versatility and efficiency in its brilliant reduced size. We have expanded its possibilities so it can be included in all types of installations.

Via Recessed

R

STANDARD
AUTOTEST
INTELLIGENT DALI
INTELLIGENT WIRELESS
CENTRAL BATTERY SYSTEM

NOW
WIRELESS VERSION
Intelligent Wireless

CE IP 40 / 65 IK 04 LIGHT RANGE 190-415 lm

Recessed IP40

Recessed waterproof IP65



Via Surface

S

STANDARD
AUTOTEST
INTELLIGENT DALI
CENTRAL BATTERY SYSTEM

CE IP 40 IK 04 LIGHT RANGE 190-415 lm

Surface mounting

Electrified track mounting



LIGHT EFFICIENCY. CEILING MOUNTING

VV | VMV | VTV | VCV | VLV

Corridors 220 lm.

Corridor length: 2 m.
Target: 1 lux

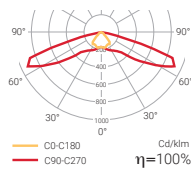
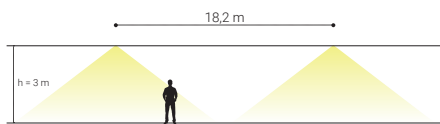

INTERDISTANCE

POSITION	HEIGHT (m)	
		3,0
⊙ → ⊙	6,5	7,7
⊙ → ⊙	18,2	21,4
⊙ → ▮	7,8	8,1
⊙ → ▮	2,9	3,2

For other heights, please consult
Take into account the orientation of
the luminaire in the VV models.

VS | VMS | VTS | VCS | VLS | VSLS

Areas 210 lm.

Corridor length: 2 m.
Target: 1 lux

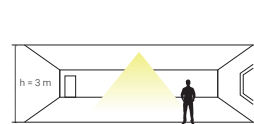

Surface:
52,81 m²

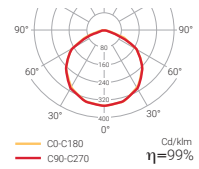

INTERDISTANCE

POSITION	HEIGHT (m)			HEIGHT (m)	AREA (m ²)
		3,0	4,0		
⊙ → ⊙	10,3	11,3	11,7	3,0	52,81
⊙ → ▮	4,0	4,1	4,1	3,5	55,41
				4,0	58,08
				5,0	51,58

In the VS model, the orientation of the light
does not affect the distribution of light.

! The data shown are referred to maintained models

! Photometric curves of VV and VS are applicable to all VIA models



Some versions compliant with French Regulation

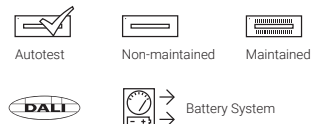

Compatible with **NormaLINK**

Via wall



**STANDARD
AUTOTEST
INTELLIGENT DALI
CENTRAL BATTERY SYSTEM**



For stave ceiling

Ceiling surface mounting

Ceiling suspended mounting

N



N



N



Wall

Outdoors wall mounted

Cylindrical wall mounted



N



N



LIGHT EFFICIENCY. WALL MOUNTING

VPV | VPVS | VPLV

Corridors 220 lm.

Corridor length: 2 m.
Target: 1 lux

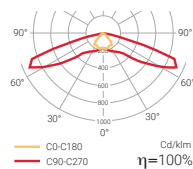
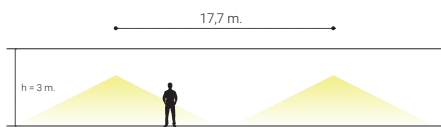

INTERDISTANCE

POSITION	HEIGHT (m)					
	1,5	2	2,5	3	3,5	4
⊕ → ⊕	11,0	13,6	15,7	17,9	19,7	21,0
⊙ → ⊙	4,3	5,0	5,6	6,3	7,0	7,4

VPS | VPSS | VPLS

Areas 210 lm.

Corridor length: 2 m.
Target: 1 lux

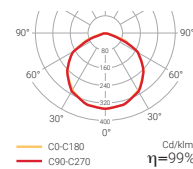
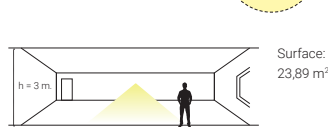

INTERDISTANCE

POSITION	HEIGHT (m)						HEIGHT (m)	AREA (m ²)
	1,5	2	2,5	3	3,5	4		
⊕ → ⊕	7,0	8,2	9,3	10,2	10,8	11,2	1,5	16,08
⊙ → ⊙	7,0	8,2	9,3	10,2	10,8	11,2	2,0	19,24
							2,5	21,50
							3,0	25,13
							3,5	27,70
							4,0	29,04

! Save in the number of units needed



Now
IP40

Via R recessed

! Available in black finishing (Ref -4)

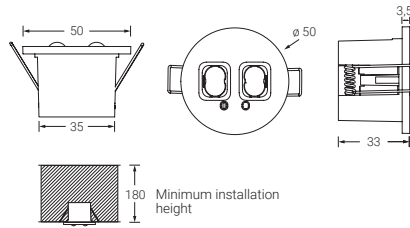

180 Minimum installation height

DRV VIA LED

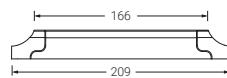
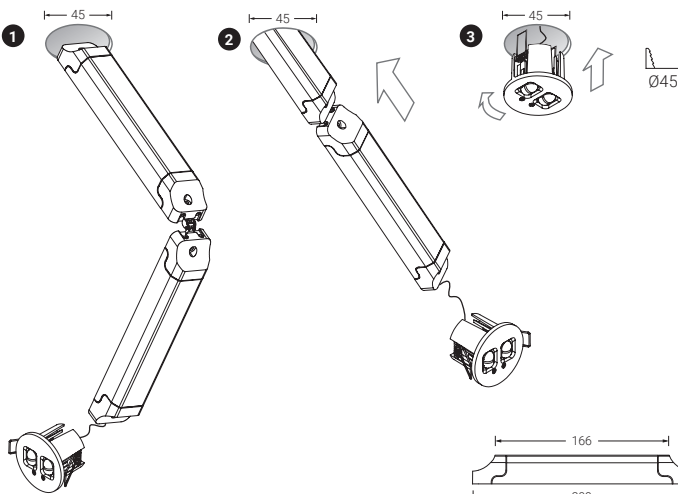

CE 850°C LED



Lm 190-415 1-3



Ni-Cd

IP 40 IK 04

230 Vac 24 Vdc

EN 60598-2-22

+ Possibility of remote control.

Via R

Standard

Non-maintained

IP
40

	FINISHING	COM.	LUMEN OUTPUT	AUTONOMY		PACKAGING
VSE	White	—	205 lm	1 h	0,2	20
VVE	White	—	205 lm	1 h	0,3	20
VSEH	White	—	410 lm	1 h	0,5	20
VVEH	White	—	415 lm	1 h	0,5	20
VSE3	White	—	205 lm	3 h	0,4	20
VVE3	White	—	205 lm	3 h	0,4	20

127v 50/60Hz also available upon request. Indicate reference + V

Maintained / Non-maintained

IP
40

	FINISHING	COM.	LUMEN OUTPUT	AUTONOMY		PACKAGING
VS	White	—	210 lm	1 h	0,5	20
VV	White	—	220 lm	1 h	0,6	20
VS3	White	—	210 lm	3 h	0,5	20
VV3	White	—	220 lm	3 h	0,5	20

127v 50/60Hz also available upon request. Indicate reference + V

Autotest

Non-maintained

IP
40

	FINISHING	COM.	LUMEN OUTPUT	AUTONOMY		PACKAGING
VSEA	White	—	195 lm	1 h	0,2	20
VVEA	White	—	195 lm	1 h	0,3	20
VSEAH	White	—	410 lm	1 h	0,5	20
VVEAH	White	—	415 lm	1 h	0,5	20
VSEA3	White	—	210 lm	3 h	0,4	20
VVEA3	White	—	220 lm	3 h	0,4	20

127v 50/60Hz also available upon request. Indicate reference + V

Maintained / Non-maintained

IP
40

	FINISHING	COM.	LUMEN OUTPUT	AUTONOMY		PACKAGING
VSA	White	—	210 lm	1 h	0,5	20
VVA	White	—	220 lm	1 h	0,6	20
VSA3	White	—	210 lm	3 h	0,5	20
VVA3	White	—	220 lm	3 h	0,5	20

127v 50/60Hz also available upon request. Indicate reference + V

Via R

Intelligent DALI

Compatible with **NormaLINK**

Non-maintained

IP
40

	FINISHING	COM.	LUMEN OUTPUT	AUTONOMY		PACKAGING
VSEID	White	DALI	210 lm	1 h	0,4	20
VVEID	White	DALI	220 lm	1 h	0,4	20
VSEIDH	White	DALI	410 lm	1 h	0,5	20
VVEIDH	White	DALI	415 lm	1 h	0,5	20
VSEID3	White	DALI	210 lm	3 h	0,4	20
VVEID3	White	DALI	220 lm	3 h	0,4	20

127v 50/60Hz also available upon request. Indicate reference + V

Maintained / Non-maintained

IP
40

	FINISHING	COM.	LUMEN OUTPUT	AUTONOMY		PACKAGING
VSID	White	DALI	210 lm	1 h	0,5	20
VVID	White	DALI	220 lm	1 h	0,6	20
VSID3	White	DALI	210 lm	3 h	0,5	20
VVID3	White	DALI	220 lm	3 h	0,5	20

127v 50/60Hz also available upon request. Indicate reference + V

Intelligent
WirelessCompatible with **NormaLINK**

New

Maintained / Non-maintained

IP
40

	FINISHING	COM.	LUMEN OUTPUT	AUTONOMY		PACKAGING
VSID-R	White	DALI	210 lm	1 h	0,6	20
VVID-R	White	DALI	210 lm	1 h	0,6	20
VSID3-R	White	DALI	210 lm	3 h	0,6	20
VVID3-R	White	DALI	220 lm	3 h	0,5	20

127v 50/60Hz also available upon request. Indicate reference + V

Central Battery
System

Maintained

IP
40

	FINISHING	POWER SUPPLY	LUMEN OUTPUT	CONSUMPTION	CURRENT		PACKAGING
C24 VS-S2L24	White	24 Vcc	210 lm	2 W	0,083 A	0,3	20
C24 VV-S2L24	White	24 Vcc	220 lm	2 W	0,083 A	0,3	20
C24i VSI-S2L24	White	24 Vcc	210 lm	2 W	0,083 A	0,3	20
C24i VVI-S2L24	White	24 Vcc	220 lm	2 W	0,083 A	0,3	20
VS-S2L	White	230 Vca	210 lm	1,9 W	0,019 A	0,3	20
VV-S2L	White	230 Vca	220 lm	1,9 W	0,019 A	0,3	20



Via R | Recessed waterproof IP65



IP 65

VVS | 220 lm

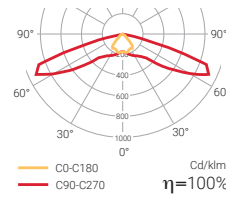

VSS | 210 lm

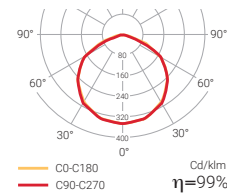

CE 850°C LED

-
- Lm**
210-220
- 1-3**
-
-
-
-
- IP 65**
- IK 04**
- 230 Vac
-

WATERPROOF

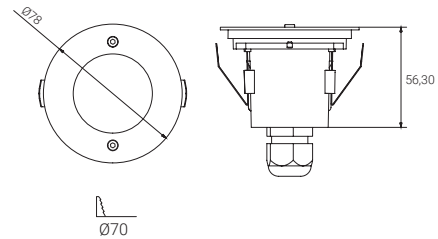

Standard

Maintained / Non-maintained

IP 65

	FINISHING	COM.	LUMEN OUTPUT	AUTONOMY		PACKAGING
VSS	White	—	210 lm	1 h	0,9	6
VVS	White	—	220 lm	1 h	0,9	6
VSS3	White	—	210 lm	3 h	0,8	6
VVS3	White	—	220 lm	3 h	0,8	6

127v 50/60Hz also available upon request. Indicate reference + V

Autotest

Maintained / Non-maintained

IP 65

	FINISHING	COM.	LUMEN OUTPUT	AUTONOMY		PACKAGING
VSSA	White	—	210 lm	1 h	0,9	6
VVSA	White	—	220 lm	1 h	0,9	6
VSSA3	White	—	210 lm	3 h	0,8	6
VVSA3	White	—	220 lm	3 h	0,8	6

127v 50/60Hz also available upon request. Indicate reference + V

Via R

Recessed waterproof IP65

Intelligent DALI

Compatible with **NormaLINK**



Maintained / Non-maintained

IP 65

	FINISHING	COM.	LUMEN OUTPUT	AUTONOMY		PACKAGING
VSSID	White	DALI	210 lm	1 h	0,9	6
VVSID	White	DALI	220 lm	1 h	0,9	6
VSSID3	White	DALI	210 lm	3 h	0,8	6
VVSID3	White	DALI	220 lm	3 h	0,8	6

127v 50/60Hz also available upon request. Indicate reference + V

Intelligent Wireless

Compatible with **NormaLINK**



New

Maintained / Non-maintained

IP 65

	FINISHING	COM.	LUMEN OUTPUT	AUTONOMY		PACKAGING
VSSID-R	White	DALI	210 lm	1 h	0,9	6
VVSID-R	White	DALI	220 lm	1 h	0,9	6
VSSID3-R	White	DALI	210 lm	3 h	0,9	6
VVSID3-R	White	DALI	220 lm	3 h	0,9	6

127v 50/60Hz also available upon request. Indicate reference + V





Via S surface

VMV | 220 lm | Corridors

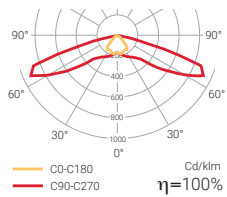

VMS | 210 lm | Areas

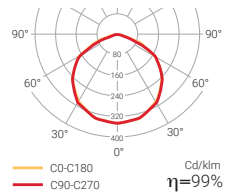

! Available in black finishing (Ref -4)

Surface ceiling mounted VIA LED. Like the recessed version it has two different versions with different light distribution, enabling it to cover large corridors (VMV Version) or large spaces (VMS version).

With a compact, elegant and minimalist design, the SURFACE VIA LED is the definitive emergency luminaire.

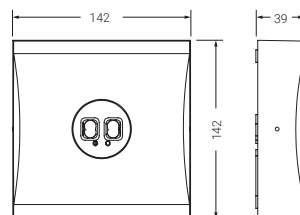

CE 850°C LED



Lm
195-415

1-3



Ni-Cd

IP
40

IK
04

230 Vac

24 Vdc



EN 60598-2-22



+ Possibility of remote controlled option.

Via S

Standard

Non-maintained

IP
40

	FINISHING	COM.	LUMEN OUTPUT	AUTONOMY		PACKAGING
VMSE	White	—	195 lm	1 h	0,5	20
VMVE	White	—	195 lm	1 h	0,5	20
VMSEH	White	—	410 lm	1 h	0,6	20
VMVEH	White	—	415 lm	1 h	0,6	20
VMSE3	White	—	195 lm	3 h	0,5	20
VMVE3	White	—	195 lm	3 h	0,5	20

127v 50/60Hz also available upon request. Indicate reference + V

Maintained / Non-maintained

IP
40

	FINISHING	COM.	LUMEN OUTPUT	AUTONOMY		PACKAGING
VMS	White	—	210 lm	1 h	0,5	20
VMV	White	—	220 lm	1 h	0,5	20
VMS3	White	—	210 lm	3 h	0,6	20
VMV3	White	—	220 lm	3 h	0,6	20

127v 50/60Hz also available upon request. Indicate reference + V

Autotest

Non-maintained

IP
40

	FINISHING	COM.	LUMEN OUTPUT	AUTONOMY		PACKAGING
VMSEA	White	—	195 lm	1 h	0,5	20
VMVEA	White	—	195 lm	1 h	0,5	20
VMSEAH	White	—	410 lm	1 h	0,6	20
VMVEAH	White	—	415 lm	1 h	0,6	20

127v 50/60Hz also available upon request. Indicate reference + V

Maintained / Non-maintained

IP
40

	FINISHING	COM.	LUMEN OUTPUT	AUTONOMY		PACKAGING
VMSA	White	—	210 lm	1 h	0,5	20
VMVA	White	—	220 lm	1 h	0,5	20
VMSA3	White	—	210 lm	3 h	0,6	20
VMVA3	White	—	220 lm	3 h	0,6	20

127v 50/60Hz also available upon request. Indicate reference + V

Via S

Intelligent DALI

Compatible with **NormaLINK** 

Non-maintained

IP
40

	FINISHING	COM.	LUMEN OUTPUT	AUTONOMY		PACKAGING
VMSEID	White	DALI	210 lm	1 h	0,5	20
VMVEID	White	DALI	220 lm	1 h	0,5	20
VMSEIDH	White	DALI	410 lm	1 h	0,6	20
VMVEIDH	White	DALI	415 lm	1 h	0,6	20
VMSEID3	White	DALI	210 lm	3 h	0,6	20
VMVEID3	White	DALI	220 lm	3 h	0,6	20

127v 50/60Hz also available upon request. Indicate reference + V

Maintained / Non-maintained

IP
40

	FINISHING	COM.	LUMEN OUTPUT	AUTONOMY		PACKAGING
VMSID	White	DALI	210 lm	1 h	0,5	20
VMVID	White	DALI	220 lm	1 h	0,5	20
VMSID3	White	DALI	210 lm	3 h	0,6	20
VMVID3	White	DALI	220 lm	3 h	0,6	20

127v 50/60Hz also available upon request. Indicate reference + V

Central Battery System

Maintained

IP
40

	FINISHING	POWER SUPPLY	LUMEN OUTPUT	CONSUMPTION	CURRENT		PACKAGING
C24 VMS-S2L24	White	24 Vcc	210 lm	1,8 W	0,075 A	0,5	20
C24 VMV-S2L24	White	24 Vcc	220 lm	1,8 W	0,075 A	0,5	20
C24i VMSI-S2L24	White	24 Vcc	210 lm	2 W	0,083 A	0,5	20
C24i VMVI-S2L24	White	24 Vcc	220 lm	2 W	0,083 A	0,5	20
C24 VMS-S2LH24	White	24 Vcc	410 lm	3,6 W	0,150 A	0,5	20
C24i VMSI-S2LH24	White	24 Vcc	410 lm	4 W	0,167 A	0,5	20
VMS-S2L	White	230 Vca	210 lm	1,9 W	0,019 A	0,5	20
VMV-S2L	White	230 Vca	220 lm	1,9 W	0,019 A	0,5	20



Via S | Electrified track mounting



Version to be installed in electrified rail, designed according to the UNE-EN 60598.2.22

VTV | 220 lm

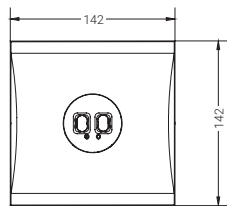
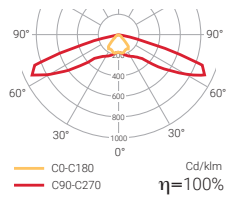

CE 850°C LED



Lm
210-220

1



Ni-Cd

IP 40

IK 04

230 Vac



EN 60598-2-22

VTS | 210 lm

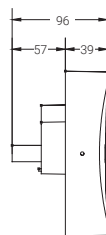
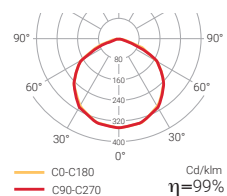

Via S

Electrified track mounting

Standard

Maintained / Non-maintained

IP 40

	FINISHING	COM.	LUMEN OUTPUT	AUTONOMY		PACKAGING
VTS	White	—	210 lm	1 h	0,5	10
VTV	White	—	220 lm	1 h	0,5	20

127v 50/60Hz also available upon request. Indicate reference + V

Autotest

Maintained / Non-maintained

IP 40

	FINISHING	COM.	LUMEN OUTPUT	AUTONOMY		PACKAGING
VTSA	White	—	210 lm	1 h	0,5	20
VTVA	White	—	220 lm	1 h	0,5	10

127v 50/60Hz also available upon request. Indicate reference + V

Intelligent DALI

Maintained / Non-maintained

IP 40

Compatible with **NormaLINK** 



	FINISHING	COM.	LUMEN OUTPUT	AUTONOMY		PACKAGING
VTSID	White	DALI	210 lm	1 h	0,5	20
VTVID	White	DALI	220 lm	1 h	0,5	20

127v 50/60Hz also available upon request. Indicate reference + V



Via S | For stave ceiling



New



VCV | 220 lm

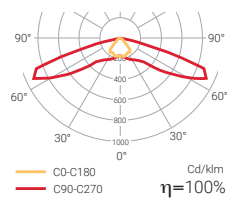

VCS | 210 lm

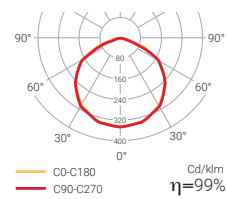

CE 850°C LED



Lm
210-220

1-3



IP
40

IK
04



EN 60598-2-22

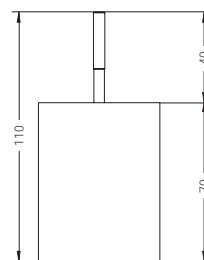
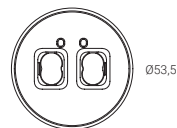

DRV VIA LED

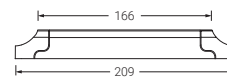

Available in black finishing (Ref -4)

Standard

Maintained / Non-maintained

IP
40

	FINISHING	COM.	LUMEN OUTPUT	AUTONOMY		PACKAGING
VCS	White	—	210 lm	1 h	0,8	20
VCV	White	—	220 lm	1 h	0,8	20
VCS3	White	—	210 lm	3 h	0,8	20
VCV3	White	—	220 lm	3 h	0,8	20

127v 50/60Hz also available upon request. Indicate reference + V

Via S

For stave ceiling

Autotest

Maintained / Non-maintained

IP 40

	FINISHING	COM.	LUMEN OUTPUT	AUTONOMY		PACKAGING
VCSA	White	–	210 lm	1 h	0,8	20
VCVA	White	–	220 lm	1 h	0,8	20
VCSA3	White	–	210 lm	3 h	0,8	20
VCVA3	White	–	220 lm	3 h	0,8	20

127v 50/60Hz also available upon request. Indicate reference + V

Intelligent DALI

Compatible with **NormaLINK** 



Maintained / Non-maintained

IP 40

	FINISHING	COM.	LUMEN OUTPUT	AUTONOMY		PACKAGING
VCSID	White	DALI	210 lm	1 h	0,8	20
VCVID	White	DALI	220 lm	1 h	0,8	20
VCSID3	White	DALI	210 lm	3 h	0,8	20
VCVID3	White	DALI	220 lm	3 h	0,8	20

127v 50/60Hz also available upon request. Indicate reference + V



Via S | Ceilling surface mounting



New

VLV | 220 lm

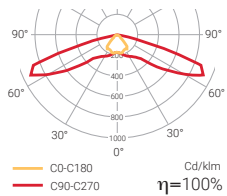

VLS | 210 lm

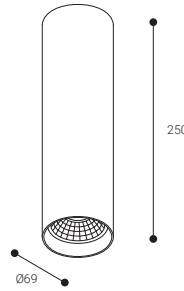
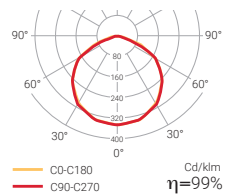

! Available in black finishing (Ref -4)

CE 55°C LED



Lm
210-220

1-3



IP
40

IK
04



EN 60598-2-22

Standard

Maintained / Non-maintained

IP
40

	FINISHING	COM.	LUMEN OUTPUT	AUTONOMY		PACKAGING
VLS	White	—	210 lm	1 h	0,8	20
VLV	White	—	220 lm	1 h	0,8	20
VLSA3	White	—	210 lm	3 h	0,8	20
VLVA3	White	—	220 lm	3 h	0,8	20

127v 50/60Hz also available upon request. Indicate reference + V

Autotest

Maintained / Non-maintained

IP
40

	FINISHING	COM.	LUMEN OUTPUT	AUTONOMY		PACKAGING
VLSA	White	—	210 lm	1 h	0,8	20
VLVA	White	—	220 lm	1 h	0,8	20
VLSA3	White	—	210 lm	3 h	0,8	20
VLVA3	White	—	220 lm	3 h	0,8	20

127v 50/60Hz also available upon request. Indicate reference + V

Intelligent DALI

Maintained / Non-maintained

IP
40

Compatible with **NormaLINK**



	FINISHING	COM.	LUMEN OUTPUT	AUTONOMY		PACKAGING
VLSID	White	DALI	210 lm	1 h	0,8	20
VLVID	White	DALI	220 lm	1 h	0,8	20
VLSID3	White	DALI	210 lm	3 h	0,8	20
VLVID3	White	DALI	220 lm	3 h	0,8	20

127v 50/60Hz also available upon request. Indicate reference + V

Via S | Ceilling suspended mounting



New

VLSL | 210 lm

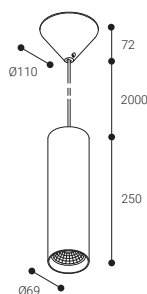
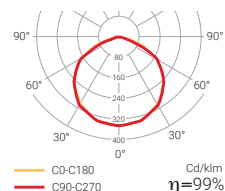

LED 850°C



Lm
210

1-3



Ni-Cd

IP
40

IK
04

230 Vac



EN 60598-2-22

Available in black finishing (Ref -4)

Standard

Maintained / Non-maintained

IP
40

	FINISHING	COM.	LUMEN OUTPUT	AUTONOMY	⚖️	PACKAGING
VLSL	White	—	210 lm	1 h	0,8	20
VLSL3	White	—	210 lm	3 h	0,8	20

127v 50/60Hz also available upon request. Indicate reference + V

Autotest

Maintained / Non-maintained

IP
40

	FINISHING	COM.	LUMEN OUTPUT	AUTONOMY	⚖️	PACKAGING
VLSA	White	—	210 lm	1 h	0,8	20
VLSA3	White	—	210 lm	3 h	0,8	20

127v 50/60Hz also available upon request. Indicate reference + V

Intelligent DALI

Maintained / Non-maintained

IP
40

Compatible with **NormaLINK**



	FINISHING	COM.	LUMEN OUTPUT	AUTONOMY	⚖️	PACKAGING
VLSID	White	—	210 lm	1 h	0,8	20
VLSID3	White	—	210 lm	3 h	0,8	20

127v 50/60Hz also available upon request. Indicate reference + V



Via W wall mounted

VPV | 220 lm

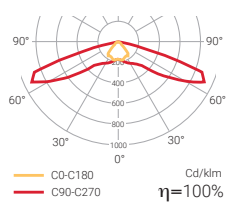

VPS | 210 lm

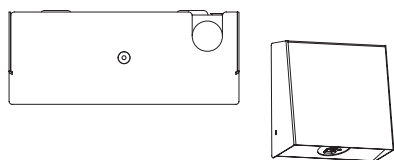
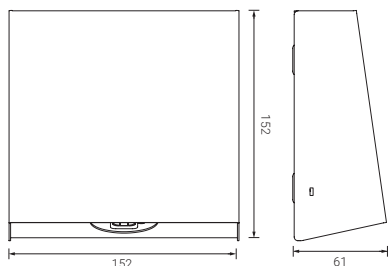
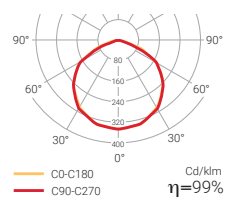

CE 850°C LED



Lm
210-220

1-3



IP
40

IK
04



230 Vac
24 Vdc



EN 60598-2-22



Possibility of remote controlled option.

Via W wall mounted

Standard

Maintained / Non-maintained

IP
40

	FINISHING	COM.	LUMEN OUTPUT	AUTONOMY		PACKAGING
VPS	White	—	210 lm	1 h	1,8	20
VPV	White	—	220 lm	1 h	1,8	20
VPS3	White	—	210 lm	3 h	1,9	20
VPV3	White	—	220 lm	3 h	1,9	20

127v 50/60Hz also available upon request. Indicate reference + V

Autotest

Maintained / Non-maintained

IP
40

	FINISHING	COM.	LUMEN OUTPUT	AUTONOMY		PACKAGING
VPSA	White	—	210 lm	1 h	1,8	20
VPVA	White	—	220 lm	1 h	1,8	20
VPSA3	White	—	210 lm	3 h	2,0	20
VPVA3	White	—	220 lm	3 h	1,9	20

127v 50/60Hz also available upon request. Indicate reference + V

Intelligent DALI

Compatible with **NormaLINK** 

Maintained / Non-maintained

IP
40

	FINISHING	COM.	LUMEN OUTPUT	AUTONOMY		PACKAGING
VPSID	White	DALI	210 lm	1 h	1,8	20
VPVID	White	DALI	220 lm	1 h	1,8	20
VPSID3	White	DALI	210 lm	3 h	1,9	20
VPVID3	White	DALI	220 lm	3 h	1,9	20

127v 50/60Hz also available upon request. Indicate reference + V

Central Battery System

Maintained

IP
40

	FINISHING	POWER SUPPLY	LUMEN OUTPUT	CONSUMPTION	CURRENT		PACKAGING
C24i	VPSI-S2L24	White	24 Vcc	210 lm	2 W	0,083 A	0,6 20
C24i	VPVI-S2L24	White	24 Vcc	220 lm	2 W	0,083 A	1,8 20

Via W | Outdoors wall mounted

IP68



New



VPVS | 175 lm

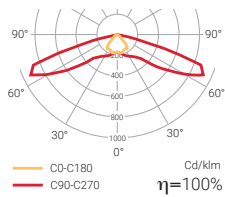

VPSS | 165 lm

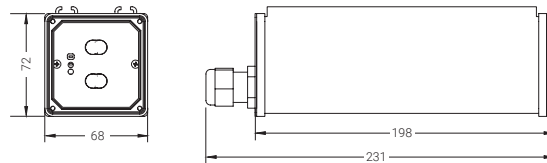
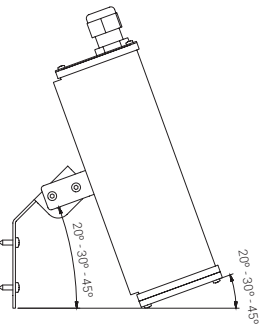
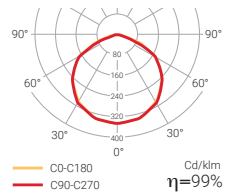

LED



Lm
155-175

1



IP
68

IK
10

230 Vac

24 Vdc



EN 60598-2-22

Available in black finishing (Ref -4)

Standard

Maintained / Non-maintained

IP
68

	FINISHING	COM.	LUMEN OUTPUT	AUTONOMY		PACKAGING
VPSS	White	—	165 lm	1 h	0,9	6
VPVS	White	—	175 lm	1 h	0,9	6

127v 50/60Hz also available upon request. Indicate reference + V

Central Battery System

Maintained

IP
68

	FINISHING	POWER SUPPLY	LUMEN OUTPUT	CONSUMPTION	CURRENT		PACKAGING	
C24i	VPSSI-S2L24	White	24 Vcc	155 lm	2,4 W	0,1 A	0,7	20
C24i	VPVSI-S2L24	White	24 Vcc	165 lm	2,4 W	0,1 A	0,9	20

Via W | Cylindrical wall mounted



New

VPLV | 220 lm

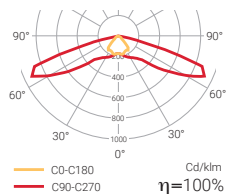

VPLS | 210 lm

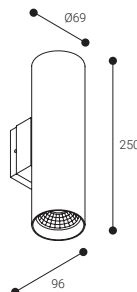
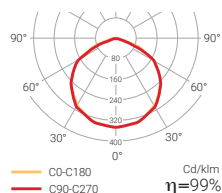

LED 850°C CE



Lm
210-220

1-3



Ni-Cd

IP 40

IK 04

230 Vac



EN 60598-2-22

Standard

Maintained / Non-maintained

IP 40

	FINISHING	COM.	LUMEN OUTPUT	AUTONOMY		PACKAGING
VPLS	White	—	210 lm	1 h	0,8	20
VPLV	White	—	220 lm	1 h	0,8	20
VPLS3	White	—	210 lm	3 h	0,8	20
VPLV3	White	—	220 lm	3 h	0,8	20

127v 50/60Hz also available upon request. Indicate reference + V

Autotest

Maintained / Non-maintained

IP 40

	FINISHING	COM.	LUMEN OUTPUT	AUTONOMY		PACKAGING
VPLSA	White	—	210 lm	1 h	0,8	20
VPLVA	White	—	220 lm	1 h	0,8	20
VPLSA3	White	—	210 lm	3 h	0,8	20
VPLVA3	White	—	220 lm	3 h	0,8	20

127v 50/60Hz also available upon request. Indicate reference + V

Intelligent DALI

Maintained / Non-maintained

IP 40

Compatible with **NormaLINK**













	FINISHING	COM.	LUMEN OUTPUT	AUTONOMY		PACKAGING
VPLSID	White	DALI	210 lm	1 h	0,8	20
VPLVID	White	DALI	220 lm	1 h	0,8	20
VPLSID3	White	DALI	210 lm	3 h	0,8	20
VPLVID3	White	DALI	220 lm	3 h	0,8	20

127v 50/60Hz also available upon request. Indicate reference + V

Via Accessories

ACCESSORIES COMPATIBILITY

			Blade diffuser	Recession frames	Fixing supports	Pictograms
Via R recessed	Recessed		V-DB V-DBL	V-R V-RR V-R-4 V-RR-4	—	PV PVL
	Recessed waterproof IP65		—	—	—	—
Via S surface	Surface mounting		V-DB V-DBL	—	V-SB	PV PVL
	Electrified track mounting		V-DB V-DBL	—	—	PV PVL
	For stave ceiling		V-DB V-DBL	—	—	PV PVL
	Ceiling surface mounting		V-DB V-DBL	—	—	PV PVL
	Ceiling suspended mounting		V-DB V-DBL	—	—	PV PVL
Via W wall	Wall		—	—	—	—
	Outdoors wall mounted		—	—	—	—
	Cylindrical wall mounted		—	—	—	PV PVL

Via Accessories

Blade diffuser



Pictogram not included

		PACKAGING
V-DB	Blade diffuser. Dimensions 161 x 114 mm. To be used with pictograms code PV.	16
V-DBL	Blade diffuser. Dimensions 210 x 210 mm. To be used with pictograms code PVL.	20

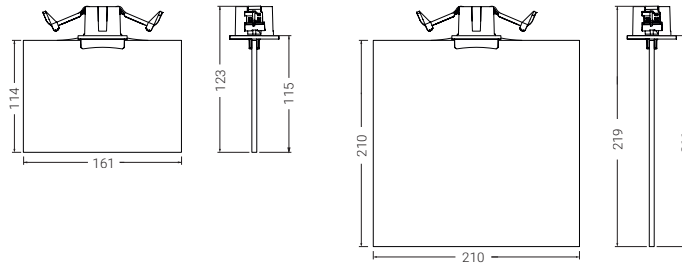

Recession frames



V-R



V-RR

		PACKAGING
V-R	95 x 95 mm white square frame for the VIA embedded range. Allows lower installation height (65mm).	20
V-RR	95 x 95 mm white round frame for the VIA embedded range. Allows lower installation height (65mm).	30
V-R-4	95 x 95 mm black square frame for the VIA embedded range. Allows lower installation height (65mm).	20
V-RR-4	95 x 95 mm black round frame for the VIA embedded range. Allows lower installation height (65mm).	20

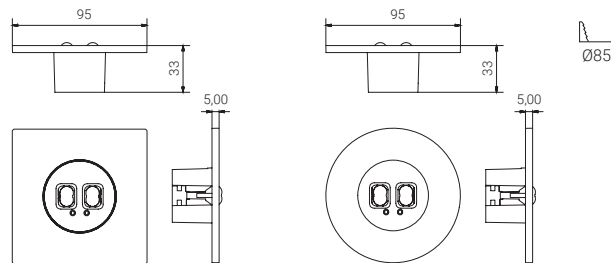

! Recession frames not compatible with the IP65 version of VIA R.

Fixing supports

		PACKAGING
V-SB	Wall mounting accessory. Only compatible with VIA LED surface mounted fittings.	20

Pictograms

Type PV	Non adhesive pictogram 160 x 115 mm. <i>References according to table below.</i>
Type PVL	Non adhesive pictogram 210 x 210 mm. <i>References according to table below.</i>

Type PV 160 x 115 mm



Maximum viewing distance (according to EN1838 for internally illuminated signs)

23 m

Type PVL 210 x 210 mm



Maximum viewing distance (according to CTE)

10 m

! Please check for other pictograms

NEW DUNNA

Renewed safety

More compact
More efficient
Easier to install

The Dunna range has earned your trust for more than half a century and now it has been renewed to offer you an even easier installation, more efficiency, compatibility and a smoother, more modern and lighter design.

Design

MORE COMPACT



Smoother lines

The new Dunna eliminates the lines in the base and offers a more pure and light design.



Looks like it is floating

The setback in the base makes the fitting look like it is floating once it has been installed.



Sustainability

Efficient and responsible

The new optic makes it possible to use less energy, and the intermediate hidden plastic piece prevents light losses. An efficient luminaire for a more sustainable world.



Installation

Even easier installation

The new Dunna beats its best known feature: an extra plastic piece in the terminal block leads the wire in effortlessly, making an easier and safer connection.



More compatibility

The new Dunna is compatible with most emergency lighting fittings in the market, making it very easy to change other brands' emergency fittings.

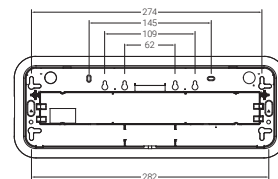

! MAXIMUM INSTALLATION COMPATIBILITY

Accessories

N New recession frame that allows the installation on technical ceiling or plasterboard wall.



D-MEL

N New waterproof box with higher IP rating.



D-MS

N New recession box for mounting on a brick wall.



D-MEP

N New blade diffuser to signal manual call points for fire.



D-DBL



New



Dunna



Some versions compliant with French Regulation

Non-maintained multiled

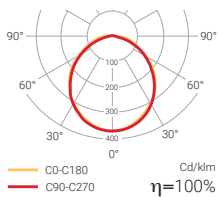

Maintained led

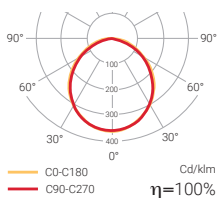

Maintained multiled

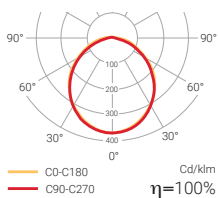

DUNNA product range reflects the experience obtained from manufacturing emergency lighting for almost half a century; it is one of our classic and most successful luminaires but it is constantly evolving. The latest LED technology and an avant-garde redesign to adapt it to modern times.

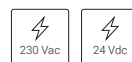
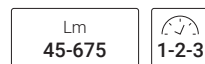
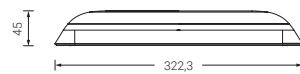

⊕ Power supply: 127 V · 50/60 Hz.



Maintained LED models available at 3000°K colour temperature. Add +W to the code.

! Opal diffuser available

Dunna

Standard

Non-maintained MULTILED

IP
44

	FINISHING	COM.	LUMEN OUTPUT	AUTONOMY		PACKAGING
D-30L	White	—	45 lm	1 h	0,5	20
D-30L-1	Anthracite	—	45 lm	1 h	0,5	20
D-30L-2	Aluminium	—	45 lm	1 h	0,5	20
D-60L	White	—	60 lm	1 h	0,5	20
D-60L-1	Anthracite	—	60 lm	1 h	0,5	20
D-60L-2	Aluminium	—	60 lm	1 h	0,5	20
D-100L	White	—	110 lm	1 h	0,5	20
D-100L-1	Anthracite	—	110 lm	1 h	0,5	20
D-100L-2	Aluminium	—	110 lm	1 h	0,5	20
D-150L	White	—	140 lm	1 h	0,5	20
D-150L-1	Anthracite	—	140 lm	1 h	0,5	20
D-150L-2	Aluminium	—	140 lm	1 h	0,5	20
D-200L	White	—	200 lm	1 h	0,5	20
D-200L-1	Anthracite	—	200 lm	1 h	0,5	20
D-200L-2	Aluminium	—	200 lm	1 h	0,5	20
D-300L	White	—	330 lm	1 h	0,5	20
D-300L-1	Anthracite	—	330 lm	1 h	0,5	20
D-300L-2	Aluminium	—	330 lm	1 h	0,5	20
D-400L	White	—	400 lm	1 h	0,6	20
D-400L-1	Anthracite	—	400 lm	1 h	0,6	20
D-400L-2	Aluminium	—	400 lm	1 h	0,6	20
D-500L	White	—	480 lm	1 h	0,6	20
D-500L-1	Anthracite	—	480 lm	1 h	0,6	20
D-500L-2	Aluminium	—	480 lm	1 h	0,6	20
D-600L	White	—	580 lm	1 h	0,7	20
D-600L-1	Anthracite	—	580 lm	1 h	0,7	20
D-600L-2	Aluminium	—	580 lm	1 h	0,7	20
D-700L	White	—	675 lm	1 h	0,8	20
D-700L-1	Anthracite	—	675 lm	1 h	0,8	20
D-700L-2	Aluminium	—	675 lm	1 h	0,8	20
D2-200L	White	—	200 lm	2 h	0,6	20
D2-200L-1	Anthracite	—	200 lm	2 h	0,6	20
D2-200L-2	Aluminium	—	200 lm	2 h	0,6	20
D2-400L	White	—	410 lm	2 h	0,7	20
D2-400L-1	Anthracite	—	410 lm	2 h	0,7	20
D2-400L-2	Aluminium	—	410 lm	2 h	0,7	20
D3-60L	White	—	60 lm	3 h	0,5	20
D3-60L-1	Anthracite	—	60 lm	3 h	0,5	20
D3-60L-2	Aluminium	—	60 lm	3 h	0,5	20
D3-200L	White	—	200 lm	3 h	0,6	20
D3-200L-1	Anthracite	—	200 lm	3 h	0,6	20
D3-200L-2	Aluminium	—	200 lm	3 h	0,6	20

Available in 127v AC 50/60Hz. Indicate reference + V.
Available in 24v DC. Indicate reference + C.

Dunna

Standard



Maintained LED models available at 3000°K colour temperature. Add +W to the code.

Maintained LED

IP 44

	FINISHING	COM.	LUMEN OUTPUT	AUTONOMY		PACKAGING
DL-100	White	—	130 lm	1 h	0,5	20
DL-100-1	Anthracite	—	130 lm	1 h	0,5	20
DL-100-2	Aluminium	—	130 lm	1 h	0,5	20
DL-150	White	—	170 lm	1 h	0,5	20
DL-150-1	Anthracite	—	170 lm	1 h	0,5	20
DL-150-2	Aluminium	—	170 lm	1 h	0,5	20
DL-200	White	—	230 lm	1 h	0,5	20
DL-200-1	Anthracite	—	230 lm	1 h	0,5	20
DL-200-2	Aluminium	—	230 lm	1 h	0,5	20
DL-300	White	—	360 lm	1 h	0,5	20
DL-300-1	Anthracite	—	360 lm	1 h	0,5	20
DL-300-2	Aluminium	—	360 lm	1 h	0,5	20
DL-400	White	—	400 lm	1 h	0,6	20
DL-400-1	Anthracite	—	400 lm	1 h	0,6	20
DL-400-2	Aluminium	—	400 lm	1 h	0,6	20
DL-500	White	—	480 lm	1 h	0,7	20
DL-500-1	Anthracite	—	480 lm	1 h	0,7	20
DL-500-2	Aluminium	—	480 lm	1 h	0,7	20
DL2-200	White	—	270 lm	2 h	0,7	20
DL2-200-1	Anthracite	—	270 lm	2 h	0,7	20
DL2-200-2	Aluminium	—	270 lm	2 h	0,7	20
DL3-100	White	—	120 lm	3 h	0,7	20
DL3-100-1	Anthracite	—	120 lm	3 h	0,7	20
DL3-100-2	Aluminium	—	120 lm	3 h	0,7	20

Available in 127v AC 50/60Hz. Indicate reference + V.
Available in 24v DC. Indicate reference + C.

Maintained MULTILED

IP 44

	FINISHING	COM.	LUMEN OUTPUT	AUTONOMY		PACKAGING
DL-60M	White	—	70 lm	1 h	0,5	20
DL-60M-1	Anthracite	—	70 lm	1 h	0,5	20
DL-60M-2	Aluminium	—	70 lm	1 h	0,5	20
DL-150M	White	—	145 lm	1 h	0,5	20
DL-150M-1	Anthracite	—	145 lm	1 h	0,5	20
DL-150M-2	Aluminium	—	145 lm	1 h	0,5	20
DL-200M	White	—	170 lm	1 h	0,5	20
DL-200M-1	Anthracite	—	170 lm	1 h	0,5	20
DL-200M-2	Aluminium	—	170 lm	1 h	0,5	20
DL-300M	White	—	325 lm	1 h	0,5	20
DL-300M-1	Anthracite	—	325 lm	1 h	0,5	20
DL-300M-2	Aluminium	—	325 lm	1 h	0,5	20

Available in 127v AC 50/60Hz. Indicate reference + V.
Available in 24v DC. Indicate reference + C.

Dunna

Autotest

Non-maintained MULTILED

IP
44

	FINISHING	COM.	LUMEN OUTPUT	AUTONOMY		PACKAGING
DA-60L	White	—	70 lm	1 h	0,5	20
DA-60L-1	Anthracite	—	70 lm	1 h	0,5	20
DA-60L-2	Aluminium	—	70 lm	1 h	0,5	20
DA-100L	White	—	135 lm	1 h	0,5	20
DA-100L-1	Anthracite	—	135 lm	1 h	0,5	20
DA-100L-2	Aluminium	—	135 lm	1 h	0,5	20
DA-150L	White	—	145 lm	1 h	0,5	20
DA-150L-1	Anthracite	—	145 lm	1 h	0,5	20
DA-150L-2	Aluminium	—	145 lm	1 h	0,5	20
DA-200L	White	—	195 lm	1 h	0,5	20
DA-200L-1	Anthracite	—	195 lm	1 h	0,5	20
DA-200L-2	Aluminium	—	195 lm	1 h	0,5	20
DA-300L	White	—	290 lm	1 h	0,5	20
DA-300L-1	Anthracite	—	290 lm	1 h	0,5	20
DA-300L-2	Aluminium	—	290 lm	1 h	0,5	20
DA-400L	White	—	390 lm	1 h	0,6	20
DA-400L-1	Anthracite	—	390 lm	1 h	0,6	20
DA-400L-2	Aluminium	—	390 lm	1 h	0,6	20
DA-500L	White	—	490 lm	1 h	0,6	20
DA-500L-1	Anthracite	—	490 lm	1 h	0,6	20
DA-500L-2	Aluminium	—	490 lm	1 h	0,6	20
DA-600L	White	—	580 lm	1 h	0,7	20
DA-600L-1	Anthracite	—	580 lm	1 h	0,7	20
DA-600L-2	Aluminium	—	580 lm	1 h	0,7	20
DA2-200L	White	—	210 lm	2 h	0,5	20
DA2-200L-1	Anthracite	—	210 lm	2 h	0,5	20
DA2-200L-2	Aluminium	—	210 lm	2 h	0,5	20
DA3-200L	White	—	180 lm	3 h	0,6	20
DA3-200L-1	Anthracite	—	180 lm	3 h	0,6	20
DA3-200L-2	Aluminium	—	180 lm	3 h	0,6	20

Available in 127v AC 50/60Hz. Indicate reference + V.
Available in 24v DC. Indicate reference + C.

Dunna

Autotest

Maintained MULTILED

IP
44

	FINISHING	COM.	LUMEN OUTPUT	AUTONOMY		PACKAGING
DAL-60M	White	—	85 lm	1 h	0,5	20
DAL-60M-1	Anthracite	—	85 lm	1 h	0,5	20
DAL-60M-2	Aluminium	—	85 lm	1 h	0,5	20
DAL-100M	White	—	92 lm	1 h	0,5	20
DAL-100M-1	Anthracite	—	92 lm	1 h	0,5	20
DAL-100M-2	Aluminium	—	92 lm	1 h	0,5	20
DAL-150M	White	—	175 lm	1 h	0,5	20
DAL-150M-1	Anthracite	—	175 lm	1 h	0,5	20
DAL-150M-2	Aluminium	—	175 lm	1 h	0,5	20
DAL-200M	White	—	210 lm	1 h	0,5	20
DAL-200M-1	Anthracite	—	210 lm	1 h	0,5	20
DAL-200M-2	Aluminium	—	210 lm	1 h	0,5	20
DAL-300M	White	—	300 lm	1 h	0,5	20
DAL-300M-1	Anthracite	—	300 lm	1 h	0,5	20
DAL-300M-2	Aluminium	—	300 lm	1 h	0,5	20
DAL2-200M	White	—	200 lm	2 h	0,5	20
DAL2-200M-1	Anthracite	—	200 lm	2 h	0,5	20
DAL2-200M-2	Aluminium	—	200 lm	2 h	0,5	20
DAL3-100M	White	—	120 lm	3 h	0,5	20
DAL3-100M-1	Anthracite	—	120 lm	3 h	0,5	20
DAL3-100M-2	Aluminium	—	120 lm	3 h	0,5	20

Available in 127v AC 50/60Hz. Indicate reference + V.
Available in 24v DC. Indicate reference + C.

Intelligent DALI

Compatible with **NormaLINK** 

Non-maintained MULTILED

IP
44

	FINISHING	COM.	LUMEN OUTPUT	AUTONOMY		PACKAGING
DID-100L	White	DALI	140 lm	1 h	0,5	20
DID-100L-1	Anthracite	DALI	140 lm	1 h	0,5	20
DID-100L-2	Aluminium	DALI	140 lm	1 h	0,5	20
DID-200L	White	DALI	190 lm	1 h	0,5	20
DID-200L-1	Anthracite	DALI	190 lm	1 h	0,5	20
DID-200L-2	Aluminium	DALI	190 lm	1 h	0,5	20
DID-300L	White	DALI	300 lm	1 h	0,5	20
DID-300L-1	Anthracite	DALI	300 lm	1 h	0,5	20
DID-300L-2	Aluminium	DALI	300 lm	1 h	0,5	20
DID-400L	White	DALI	410 lm	1 h	0,6	20
DID-400L-1	Anthracite	DALI	410 lm	1 h	0,6	20
DID-400L-2	Aluminium	DALI	410 lm	1 h	0,6	20
DID-500L	White	DALI	500 lm	1 h	0,6	20
DID-500L-1	Anthracite	DALI	500 lm	1 h	0,6	20
DID-500L-2	Aluminium	DALI	500 lm	1 h	0,6	20
DID2-200L	White	DALI	200 lm	2 h	0,5	20
DID2-200L-1	Anthracite	DALI	200 lm	2 h	0,5	20
DID2-200L-2	Aluminium	DALI	200 lm	2 h	0,5	20
DID3-200L	White	DALI	200 lm	3 h	0,6	20
DID3-200L-1	Anthracite	DALI	200 lm	3 h	0,6	20
DID3-200L-2	Aluminium	DALI	200 lm	3 h	0,6	20

Available in 127v AC 50/60Hz. Indicate reference + V.
Available in 24v DC. Indicate reference + C.

Dunna

Intelligent DALI

Compatible with **NormaLINK**



Maintained MULTILED

IP 44

	FINISHING	COM.	LUMEN OUTPUT	AUTONOMY		PACKAGING
DIDL-100M	White	—	92 lm	1 h	0,5	20
DIDL-100M-1	Anthracite	—	92 lm	1 h	0,0	20
DIDL-100M-2	Aluminium	—	92 lm	1 h	0,0	20
DIDL-200M	White	—	210 lm	1 h	0,5	20
DIDL-200M-1	Anthracite	—	210 lm	1 h	0,0	20
DIDL-200M-2	Aluminium	—	210 lm	1 h	0,0	20
DIDL-300M	White	—	300 lm	1 h	0,5	20
DIDL-300M-1	Anthracite	—	300 lm	1 h	0,5	20
DIDL-300M-2	Aluminium	—	300 lm	1 h	0,5	20
DIDL2-200M	White	—	215 lm	2 h	0,5	20
DIDL2-200M-1	Anthracite	—	215 lm	2 h	0,5	20
DIDL2-200M-2	Aluminium	—	215 lm	2 h	0,5	20
DIDL3-100M	White	—	120 lm	3 h	0,5	20
DIDL3-100M-1	Anthracite	—	120 lm	3 h	0,5	20
DIDL3-100M-2	Aluminium	—	120 lm	3 h	0,5	20

Available in 127v AC 50/60Hz. Indicate reference + V.
Available in 24v DC. Indicate reference + C.

Central Battery System

Maintained MULTILED

IP 44

	FINISHING	POWER SUPPLY	LUMEN OUTPUT	CONSUMPTION	CURRENT		PACKAGING
C24	D-S32L24	White	24 Vcc	330 lm	3,5 W	0,146 A	0,4 20
C24i	DI-S32L24	White	24 Vcc	330 lm	3 W	0,125 A	0,4 20
	D-S3L	White	230 Vca	300 lm	3,5 W	0,040 A	0,6 20



Dunna Accessories

Diffuser blade



		PACKAGING
D-DB	Blade diffuser. Dimensions 332x132 mm	20
D-DBL	Long blade diffuser Dimensions 332x243 mm To be used with pictograms code PDUL	20

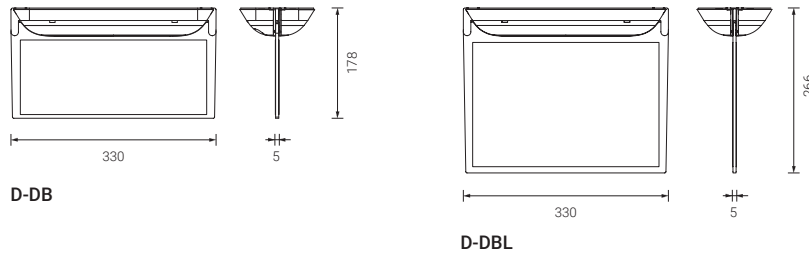

Recession frames



D-MEL



D-MEP

		PACKAGING
D-MEL	Recession frame for ceiling or laminated plasterboard White colour	20
D-MEP	Recession box and frame kit for wall installation. White colour	20

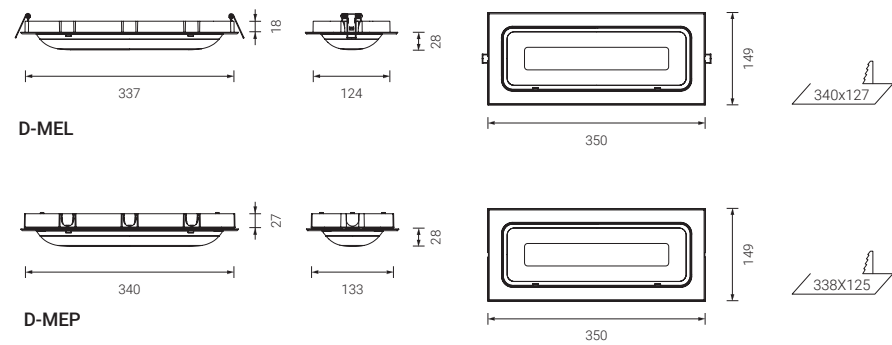

Recession frames with diffuser blade



D-DBEL



D-DBELL

		PACKAGING
D-DBEL	Recession box for ceiling and blade diffuser. To be used with pictograms code N and LN. White colour	12
D-DBELL	Recession box for ceiling and long blade diffuser. To be used with pictograms code PDUL. White colour	12

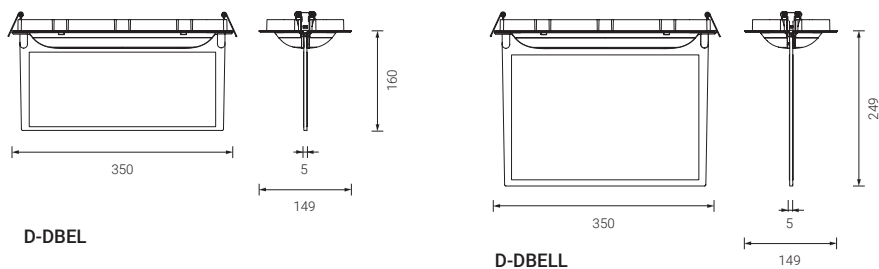

Dunna Accessories

Assembly adaptors



D-AT Adapter to use tube 20 metric

PACKAGING

20



IP66 / IP65 Housings



D-MS

D-MS IP66 IK10 box
DM-DB IP65 IK07 box with blade diffuser

PACKAGING

20

20

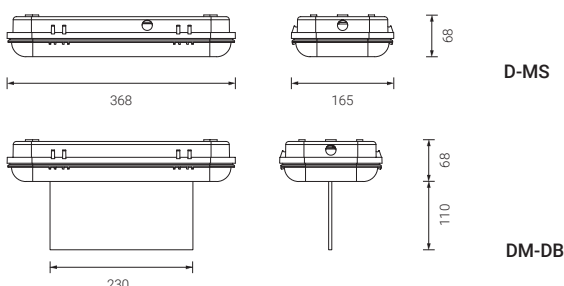

Fixing supports

U-SBL Wall fixation for DUNNA range fittings
U-AV Antivandalic enclosure
D-KS Suspension kit for Dunna range, 300 mm

Remote controls

S-TE Remote control for up to 300 fittings standard or autotest

Pictograms

Type N Adhesive pictogram 150 x 90 mm. Only for use in the flag diffuser DM-DB y DE-DB. *References according to table below*

Type LN Adhesive pictogram 230 x 110 mm. Only for use in the flag diffuser DM-DB. *References according to table below*

Type PDU Non adhesive pictogram 300 x 120 mm. Only for use in the flag diffuser D-DB / D-DBEL. *References according to table below*

Type PDUL Non adhesive pictogram 210 x 210 mm. *References according to table below*

Type N 150 x 90 mm

REF. N-L REF. N-R REF. N-SD REF. N-SU

Maximum viewing distance
(according to EN1838 for internally illuminated signs)

18 m

Type LN 230 x 110 mm

REF. LN-L REF. LN-R REF. LN-SD REF. LN-SU

Maximum viewing distance
(according to EN1838 for internally illuminated signs)

22 m

Type PDU 300 x 120 mm

REF. PDU-A REF. PDU-A REF. PDU-SD REF. PDU-SU

Maximum viewing distance
(according to EN1838 for internally illuminated signs)

24 m

Type PDUL 210 x 210 mm

REF. PDUL-BIE REF. PDUL-EXT REF. PDUL-PUL

Maximum viewing distance
(according to CTE)

10 m

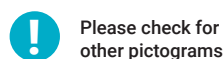



Stylo

Maintained / Non-maintained multiled

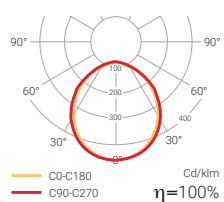

The STYLO luminaire upgrades the concept of simplicity to a higher level. It is the ideal luminaire to meet basic emergency lighting needs with an attractive design.

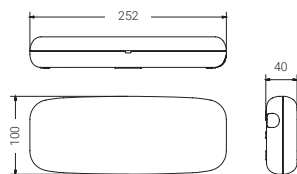

CE 850°C LED



Lm
40-500

1-2



Ni-Cd

IP **44**

IK **04**

230 Vac



EN 60598-2-22

Stylo

Standard

Non-maintained MULTILED

IP

44

	FINISHING	COM.	LUMEN OUTPUT	AUTONOMY		PACKAGING
S-30L	White	—	40 lm	1 h	0,4	20
S-60L	White	—	70 lm	1 h	0,4	20
S-100L	White	—	115 lm	1 h	0,4	20
S-150L	White	—	145 lm	1 h	0,4	20
S-200L	White	—	195 lm	1 h	0,4	20
S-300L	White	—	320 lm	1 h	0,4	20
S-400L	White	—	385 lm	1 h	0,4	20
S-500L	White	—	500 lm	1 h	0,4	20
S2-200L	White	—	270 lm	2 h	0,4	20
S3-100L	White	—	125 lm	3 h	0,4	20

Available in 127v AC 50/60Hz. Indicate reference + V.
Available in 24v DC. Indicate reference + C.

Maintained MULTILED

IP

44

	FINISHING	COM.	LUMEN OUTPUT	AUTONOMY		PACKAGING
SL-60M	White	—	80 lm	1 h	0,4	20
SL-150M	White	—	160 lm	1 h	0,4	20
SL-200M	White	—	195 lm	1 h	0,4	20
SL-300M	White	—	280 lm	1 h	0,4	20
SL3-100M	White	—	105 lm	3 h	0,4	20

Available in 127v AC 50/60Hz. Indicate reference + V.
Available in 24v DC. Indicate reference + C.

Autotest

Non-maintained MULTILED

IP

44

	FINISHING	COM.	LUMEN OUTPUT	AUTONOMY		PACKAGING
SA-60L	White	—	70 lm	1 h	0,4	20
SA-100L	White	—	125 lm	1 h	0,4	20
SA-150L	White	—	160 lm	1 h	0,4	20
SA-200L	White	—	195 lm	1 h	0,4	20
SA-300L	White	—	290 lm	1 h	0,4	20
SA-400L	White	—	440 lm	1 h	0,4	20
SA3-200L	White	—	185 lm	3 h	0,4	20

Available in 127v AC 50/60Hz. Indicate reference + V.
Available in 24v DC. Indicate reference + C.

Maintained MULTILED

IP

44

	FINISHING	COM.	LUMEN OUTPUT	AUTONOMY		PACKAGING
SAL-60M	White	—	75 lm	1 h	0,4	20
SAL-150M	White	—	160 lm	1 h	0,4	20
SAL-200M	White	—	195 lm	1 h	0,4	20
SAL-300M	White	—	290 lm	1 h	0,4	20

Available in 127v AC 50/60Hz. Indicate reference + V.
Available in 24v DC. Indicate reference + C.

Stylo Accessories

Blade diffuser

S-DB	Flag diffuser. Compatible with all the fittings of the STYLO range.
S-DBE	Embedded mounted blade diffuser. Compatible with all the fittings for the STYLO range using the S-ME accessorie.
S-DBP	Wall mounted flag diffuser (surface mounted). Compatible with all the fittings of the STYLO range.
S-DBPE	Wall mounted blade diffuser Compatible with all the fittings for the STYLO range using the S-ME accessory

STYLO + S-DB + Pictogram Type PD



STYLO + S-ME + S-DBE + Pictogram Type PD



STYLO + S-DBP + Pictogram Type N



STYLO + S-ME + S-DBPE + Pictogram Type N



Recession frames



Valid for ceilings and concrete walls

S-ME	Recessed mounting frame for the STYLO range	PACKAGING 20
-------------	---	-----------------

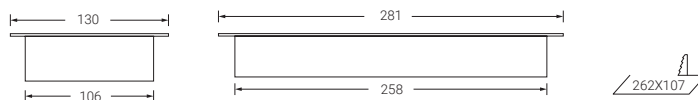

Wall and ceiling mounting accessories

S-KS	Ceiling suspension with 300 mm with aluminium rod (2 units)
U-SBC	Wall fixation bracket



S-KS

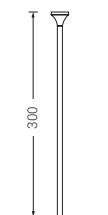

U-SBC + S-DB

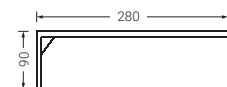

Stylo Accessories

Waterproof box



S-MS

IP65 IK07 box for the STYLO range.

PACKAGING

20

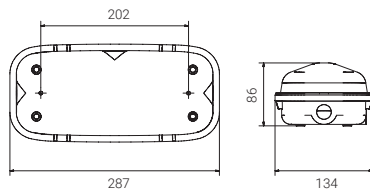

Remote controls



S-TE

Remote control for up to 300 fittings standard or autotest

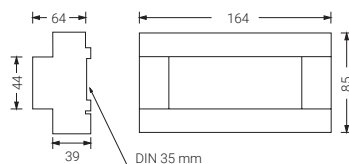

Pictograms

Type LN

Adhesive pictogram 230 x 110 mm. *References according to table below*

Type PD

Non adhesive pictogram 240 x 120 mm. *References according to table below*

Type LN 230 x 110 mm



Maximum viewing distance
(according to EN1838 for
internally illuminated signs)

22 m

Type PD 240 x 120 mm



Maximum viewing distance
(according to EN1838 for
internally illuminated signs)

24 m



Please check for other pictograms

Antivandalic enclosure

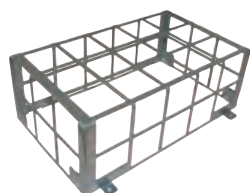

U-AV

Universal antivandalic enclosure 37 x 19.8 x 9 cm



N

New waterproof box

IP67

GS

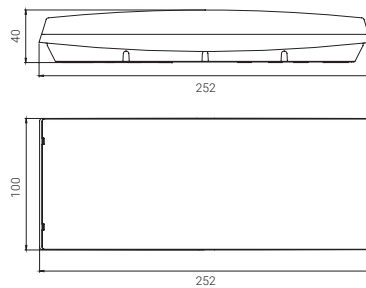
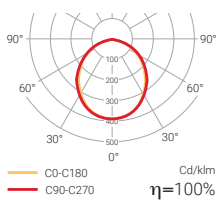

Lm
70-500

1-2



Ni-Cd

IP
44

IK
07

230 Vac



EN 60598-2-22

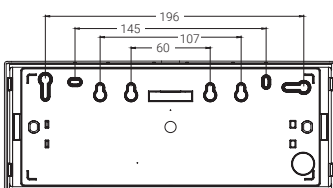

! MAXIMUM INSTALLATION COMPATIBILITY

! Suitable for use with remote control (Only non maintained fittings)

+ Remote controlled

GS

Standard

Non-maintained MULTILED

IP
44

	FINISHING	COM.	LUMEN OUTPUT	AUTONOMY		PACKAGING
G-60L	White	—	70 lm	1 h	0,3	30
G-100L	White	—	110 lm	1 h	0,3	30
G-150L	White	—	150 lm	1 h	0,3	30
G-200L	White	—	210 lm	1 h	0,3	30
G-300L	White	—	325 lm	1 h	0,4	30
G-400L	White	—	400 lm	1 h	0,4	30
G-500L	White	—	500 lm	1 h	0,4	30
G2-100L	White	—	126 lm	2 h	0,3	30
G2-300L	White	—	305 lm	2 h	0,4	30
G3-100L	White	—	130 lm	3 h	0,4	30
G3-200L	White	—	200 lm	3 h	0,4	30

127v 50/60Hz also available upon request. Indicate reference + V

Maintained MULTILED

IP
44

	FINISHING	COM.	LUMEN OUTPUT	AUTONOMY		PACKAGING
GL-60	White	—	80 lm	1 h	0,3	30
GL-100	White	—	100 lm	1 h	0,3	30
GL-150	White	—	170 lm	1 h	0,3	30
GL-200	White	—	200 lm	1 h	0,3	30
GL-300	White	—	300 lm	1 h	0,3	30
GL3-100	White	—	110 lm	3 h	0,4	30

127v 50/60Hz also available upon request. Indicate reference + V

Autotest

Non-maintained MULTILED

IP
44

	FINISHING	COM.	LUMEN OUTPUT	AUTONOMY		PACKAGING
GA-60L	White	—	70 lm	1 h	0,3	30
GA-100L	White	—	130 lm	1 h	0,3	30
GA-150L	White	—	170 lm	1 h	0,3	30
GA-200L	White	—	200 lm	1 h	0,3	30
GA-300L	White	—	310 lm	1 h	0,4	30
GA-400L	White	—	465 lm	1 h	0,4	30
GA3-200L	White	—	195 lm	3 h	0,4	30

127v 50/60Hz also available upon request. Indicate reference + V

Maintained MULTILED

IP
44

	FINISHING	COM.	LUMEN OUTPUT	AUTONOMY		PACKAGING
GAL-60	White	—	75 lm	1 h	0,3	20
GAL-150	White	—	155 lm	1 h	0,3	30
GAL-200	White	—	190 lm	1 h	0,3	30
GAL-300	White	—	310 lm	1 h	0,3	30

127v 50/60Hz also available upon request. Indicate reference + V

GS Accessories

Blade diffuser

G-DB	Blade diffuser. Compatible with all the fittings of the GS range.
G-DBE	Embedded mounted blade diffuser. Compatible with all the fittings for the GS range using the G-ME accessory.
G-DBP	Wall mounted blade diffuser (surface mounted). Compatible with all the fittings of the GS range.
G-DBPE	Wall mounted flag diffuser (embedded mounted). Compatible with all the fittings for the GS range using the G-ME accessory.

GS + G-DB + Pictogram Type PD



GS + G-ME + G-DBE + Pictogram Type PD



GS + G-DBP + Pictogram Type N



GS + G-ME + G-DBPE + Pictogram Type N



Recession frames

G-ME	Recession frame for GS luminaires. White colour
G-ME-1	Recession frame for GS luminaires. Anthracite colour
G-ME-2	Recession frame for GS luminaires. Aluminium colour

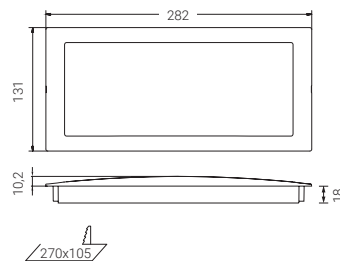

GS Accessories

Waterproof housing kit

G-AMS IP65 kit (watertight rubber, PG7 cable gland and joints for screws)

N **G-MS** IP67 IK10 box for the GS range.

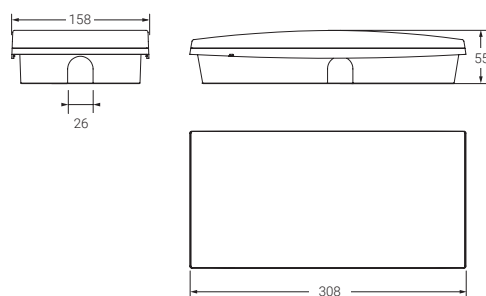

Adapter

O-AT M20 tube mounting accessory. It does not keep IP67

Remote controls



S-TE Remote control for up to 300 fittings standard or autotest

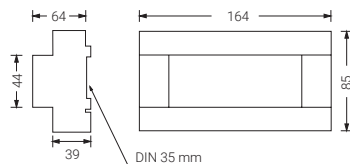

Pictograms

Type LN Adhesive pictogram 230 x 110 mm. *References according to table below*

Type PD Non adhesive pictogram 240 x 120 mm. *References according to table below*

Type LN 230 x 110 mm



Maximum viewing distance
(according to EN1838 for
internally illuminated signs)

22 m

Type PD 240 x 120 mm



Maximum viewing distance
(according to EN1838 for
internally illuminated signs)

24 m



Please check for other pictograms



New



Up to 1200
lumen output

Hermetic

Maintained led

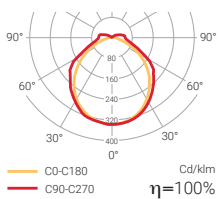

Maintained / Non-maintained multiled

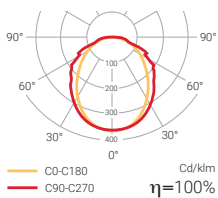

The HERMETIC range has been designed to guarantee function in the most demanding buildings. Its IP65 combined with a wide range of versions makes it the perfect choice for large industrial areas, tunnels or car parks.

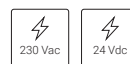
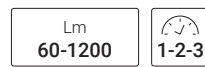
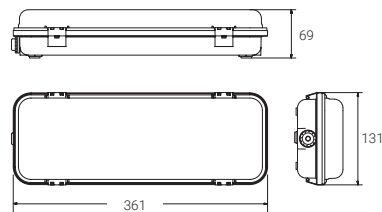

New improved optics



Remote controlled

Hermetic

Standard

Non-maintained MULTILED

IP
65

	FINISHING	COM.	LUMEN OUTPUT	AUTONOMY		PACKAGING
DE-60L	White	—	60 lm	1 h	0,7	20
DE-100L	White	—	110 lm	1 h	0,7	20
DE-150L	White	—	140 lm	1 h	0,7	20
DE-200L	White	—	200 lm	1 h	0,7	20
DE-300L	White	—	330 lm	1 h	0,7	20
DE-400L	White	—	400 lm	1 h	0,8	20
DE-500L	White	—	500 lm	1 h	0,8	20
DE-600L	White	—	620 lm	1 h	0,9	20
DE-1100L	White	—	1200 lm	1 h	1,0	20
DE2-200L	White	—	200 lm	2 h	0,8	20
DE2-400L	White	—	410 lm	2 h	0,9	20
DE3-60L	White	—	60 lm	3 h	0,7	20
DE3-200L	White	—	200 lm	3 h	0,8	20

Available in 127v AC 50/60Hz. Indicate reference + V.
24Vcc also available upon request. Indicate reference + C.

Maintained LED

IP
65

	FINISHING	COM.	LUMEN OUTPUT	AUTONOMY		PACKAGING
DEL-100	White	—	110 lm	1 h	0,7	20
DEL-150	White	—	150 lm	1 h	0,7	20
DEL-200	White	—	200 lm	1 h	0,7	20
DEL-300	White	—	330 lm	1 h	0,7	20
DEL-400	White	—	395 lm	1 h	0,8	20
DEL-500	White	—	480 lm	1 h	0,9	20
DEL2-200	White	—	270 lm	2 h	1,4	20
DEL3-100	White	—	120 lm	3 h	1,3	20

Available in 127v AC 50/60Hz. Indicate reference + V.
24Vcc also available upon request. Indicate reference + C.

Maintained MULTILED

IP
65

	FINISHING	COM.	LUMEN OUTPUT	AUTONOMY		PACKAGING
DEL-60M	White	—	70 lm	1 h	0,7	20
DEL-150M	White	—	145 lm	1 h	0,7	20
DEL-200M	White	—	170 lm	1 h	0,7	20
DEL-300M	White	—	325 lm	1 h	0,7	20
DEL2-200M	White	—	240 lm	2 h	0,7	20

Available in 127v AC 50/60Hz. Indicate reference + V.
24Vcc also available upon request. Indicate reference + C.

Hermetic

Autotest

Non-maintained MULTILED

IP
65

	FINISHING	COM.	LUMEN OUTPUT	AUTONOMY		PACKAGING
DEA-60L	White	—	70 lm	1 h	0,7	20
DEA-100L	White	—	110 lm	1 h	0,7	20
DEA-150L	White	—	145 lm	1 h	0,7	20
DEA-200L	White	—	195 lm	1 h	0,7	20
DEA-300L	White	—	290 lm	1 h	0,7	20
DEA-400L	White	—	390 lm	1 h	0,8	20
DEA-500L	White	—	490 lm	1 h	0,8	20
DEA2-200L	White	—	210 lm	2 h	0,7	20
DEA3-200L	White	—	180 lm	3 h	0,8	20

127V 50/60Hz 24Vcc also available upon request. Indicate reference + V.

Maintained MULTILED

IP
65

	FINISHING	COM.	LUMEN OUTPUT	AUTONOMY		PACKAGING
DEAL-100M	White	—	92 lm	1 h	0,7	20
DEAL-200M	White	—	210 lm	1 h	0,7	20
DEAL-300M	White	—	300 lm	1 h	0,7	20
DEAL2-200M	White	—	200 lm	2 h	0,7	20
DEAL3-100M	White	—	100 lm	3 h	0,9	20

127V 50/60Hz 24Vcc also available upon request. Indicate reference + V.

Intelligent DALI

Compatible with **NormaLINK** 

Non-maintained MULTILED

IP
65

	FINISHING	COM.	LUMEN OUTPUT	AUTONOMY		PACKAGING
DEID-100L	White	DALI	140 lm	1 h	0,7	20
DEID-200L	White	DALI	190 lm	1 h	0,7	20
DEID-300L	White	DALI	300 lm	1 h	0,7	20
DEID-400L	White	DALI	410 lm	1 h	0,8	20
DEID-500L	White	DALI	500 lm	1 h	0,8	20
DEID2-200L	White	DALI	200 lm	2 h	0,7	20
DEID3-200L	White	DALI	205 lm	3 h	0,8	20
DEID3-500L	White	DALI	490 lm	3 h	1,0	20

127V 50/60Hz 24Vcc also available upon request. Indicate reference + V.

Maintained MULTILED

IP
65

	FINISHING	COM.	LUMEN OUTPUT	AUTONOMY		PACKAGING
DEIDL-100M	White	DALI	92 lm	1 h	0,7	20
DEIDL-200M	White	DALI	210 lm	1 h	0,7	20
DEIDL-300M	White	DALI	300 lm	1 h	0,7	20
DEIDL2-200M	White	DALI	200 lm	2 h	0,7	20
DEIDL3-100M	White	DALI	100 lm	3 h	0,7	20

127V 50/60Hz 24Vcc also available upon request. Indicate reference + V.

Hermetic

Central Battery System

Maintained MULTILED

IP 65

		FINISHING	POWER SUPPLY	LUMEN OUTPUT	CONSUMPTION	CURRENT		PACKAGING
C24	DE-S32L24	White	24 Vcc	300 lm	3,5 W	0,146 A	0,6	20
C24i	DEI-S32L24	White	24 Vcc	310 lm	3 W	0,125 A	0,6	20
C24i	DEI-S32LH24	White	24 Vcc	450 lm	7 W	0,292 A	0,6	20
	DE-S3L	White	230 Vca	300 lm	3,5 W	0,040 A	0,8	20

Accessories

Blade diffuser



DE-DB Blade diffuser with PVC screws for the HERMETIC range



Remote controls

S-TE Remote control for up to 300 fittings standard or autotest

Pictograms

Type LN Adhesive pictogram 230 x 110 mm. *References according to table below*

Type LN 230 x 110 mm



Maximum viewing distance (according to EN1838 for internally illuminated signs)

22 m



Please check for other pictograms

Antivandalic enclosure

U-AV Universal antivandalic enclosure 37 x 19.8 x 9 cm



Hermetic EX

Maintained led

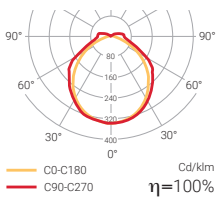

Non-maintained multiled

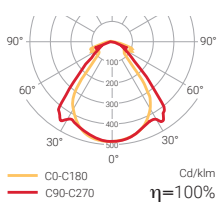

Version of the emergency luminaire HERMETIC that can be used in Category 3 locations according ATEX 2014/34/UE.

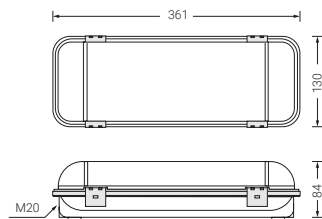

CE 850°C LED



Lm 40-290 1-2-3

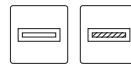

NI-Cd

IP 65 IK 10

230 Vac



EN 60598-2-22



Can be used in locations designated Category 3 in accordance with Directive ATEX 2014/34/UE.

Zones 2, 22

Hermetic EX

Standard

Non-maintained MULTILED

IP 65

	FINISHING	COM.	LUMEN OUTPUT	AUTONOMY		PACKAGING
DE-60LEX	White	—	40 lm	1 h	0,7	20
DE-100LEX	White	—	55 lm	1 h	0,7	20
DE-150LEX	White	—	65 lm	1 h	0,7	20
DE-200LEX	White	—	105 lm	1 h	0,7	20
DE-300LEX	White	—	165 lm	1 h	0,7	20
DE-400LEX	White	—	230 lm	1 h	0,8	20
DE-500LEX	White	—	290 lm	1 h	0,8	20
DE3-60LEX	White	—	60 lm	3 h	0,7	20
DE3-200LEX	White	—	105 lm	3 h	0,8	20

Available in 127v AC 50/60Hz. Indicate reference + V.
Available in 24v DC. Indicate reference + C.

Maintained

IP 65

	FINISHING	COM.	LUMEN OUTPUT	AUTONOMY		PACKAGING
DEL-60EX	White	—	40 lm	1 h	0,7	20
DEL-150EX	White	—	100 lm	1 h	0,7	20
DEL-200EX	White	—	170 lm	1 h	0,7	20
DEL-300EX	White	—	185 lm	1 h	0,7	20
DEL2-200EX	White	—	150 lm	2 h	0,7	20
DEL3-100EX	White	—	70 lm	3 h	0,7	20

Available in 127v AC 50/60Hz. Indicate reference + V.
Available in 24v DC. Indicate reference + C.

Accessories

Blade diffuser



DE-DB Blade diffuser with PVC screws for the HERMETIC EX range

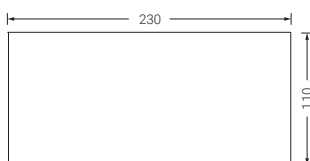

Remote controls

S-TE Remote control for up to 300 fittings standard or autotest

Pictograms

Type LN Adhesive pictogram 230 x 110 mm. *References according to table below*

 Please check for other pictograms

Type LN 230 x 110 mm



Maximum viewing distance (according to EN1838 for internally illuminated signs)

22 m



Smart



Some versions compliant with French Regulation

Maintained / Non-maintained multiled

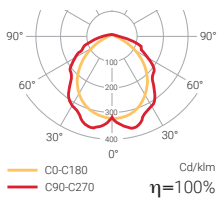

SMART is a range of emergency luminaires designed to adapt to any type of installation thanks to their stylish minimalist lines, their versatility and their ease of installation.

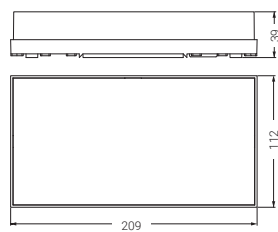

Quick assembly



Lm
70-390

1-2-3

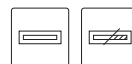

SATI

SATI ADRESSABLE

Ni-Cd

IP
42

IK
07

230 Vac



EN 60598-2-22

Remote controlled

Smart

Standard

Non-maintained MULTILED

IP
42

	FINISHING	COM.	LUMEN OUTPUT	AUTONOMY		PACKAGING
SS-100L	White	—	70 lm	1 h	0,4	20
SS-200L	White	—	190 lm	1 h	0,4	20
SS-300L	White	—	330 lm	1 h	0,5	20
SS-400L	White	—	390 lm	1 h	0,5	20
SS2-300L	White	—	260 lm	2 h	0,5	20
SS3-100L	White	—	100 lm	3 h	0,4	20

Maintained MULTILED

IP
42

	FINISHING	COM.	LUMEN OUTPUT	AUTONOMY		PACKAGING
SSL-100	White	—	130 lm	1 h	0,4	20
SSL-200	White	—	220 lm	1 h	0,5	20
SSL-300	White	—	270 lm	1 h	0,5	20

Autotest

Non-maintained MULTILED

IP
42

	FINISHING	COM.	LUMEN OUTPUT	AUTONOMY		PACKAGING
SSA-100L	White	—	70 lm	1 h	0,4	20
SSA-200L	White	—	190 lm	1 h	0,4	20
SSA-300L	White	—	300 lm	1 h	0,5	20
SSA2-300L	White	—	350 lm	2 h	0,5	20
SSA3-100L	White	—	120 lm	3 h	0,5	20

Maintained / Non-maintained MULTILED

IP
42

	FINISHING	COM.	LUMEN OUTPUT	AUTONOMY		PACKAGING
SSAL-100	White	—	130 lm	1 h	0,4	20
SSAL-200	White	—	230 lm	1 h	0,4	20
SSAL-300	White	—	320 lm	1 h	0,4	20
SSAL3-100	White	—	115 lm	3 h	0,4	20

Intelligent DALI

Compatible with **NormaLINK** 

Non-maintained MULTILED

IP
42

	FINISHING	COM.	LUMEN OUTPUT	AUTONOMY		PACKAGING
SSID-100L	White	DALI	100 lm	1 h	0,4	20
SSID-200L	White	DALI	190 lm	1 h	0,4	20
SSID-300L	White	DALI	330 lm	1 h	0,5	20

Central Battery System

IP
42

	FINISHING	POWER SUPPLY	LUMEN OUTPUT	CONSUMPTION	CURRENT		PACKAGING
SS-S25L	White	230 Vca	300 lm	3,5 W	0,018 A	0,3	20

Smart Accessories

Recession frames

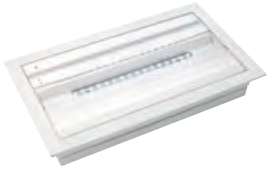

		PACKAGING
SS-ME	Recessed mounting frame for the SMART range. White colour	20

Waterproof kit

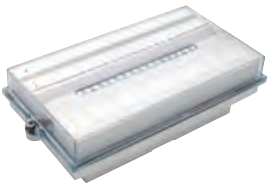

		PACKAGING
SS-MS	IP65 IK07 housing. Compatible with all the Smart range fittings	20

Blade diffuser



Embedded installation (SS-DBE)



Surface mounted (SS-DB)

		PACKAGING
SS-DB	Blade diffuser compatible with all the fittings of SMART product range	20
SS-DBE	Blade diffuser compatible with the recession frame SS-ME (not included)	20

Smart Accessories

Antivandalic enclosure

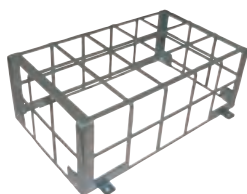

U-AVC Antivandalic enclosure

PACKAGING

20

Remote controls



S-TE Remote control for up to 300 fittings standard or autotest

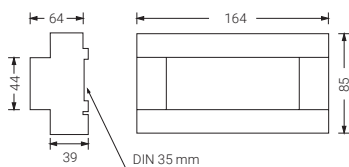

Pictograms

Type PS Non adhesive pictogram 200 x 120 mm. *References according to table below*

Type SN Adhesive pictogram 200 x 120 mm. *References according to table below*

Type PS 200 x 120 mm



Maximum viewing distance
(according to EN1838 for
internally illuminated signs)

24 m

Type SN 200 x 120 mm



Maximum viewing distance
(according to EN1838 for
internally illuminated signs)

24 m



Please check for other pictograms



Extraplana

Maintained / Non-maintained led

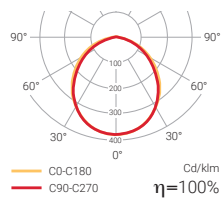

Maintained / Non-maintained multiled

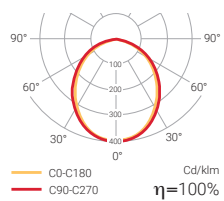

Quick assembly

The EXTRAPLANA range can tackle any project thanks to its several different models and the options provided by the accessories offered.

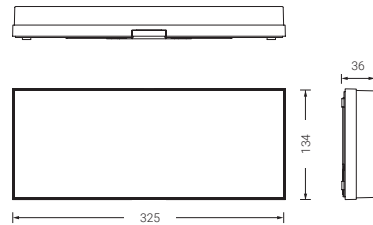

Plug-in base

850°C LED



Lm
80-520

1-2-3



Ni-Cd

IP
42-44

IK
04

230 Vac

24 Vdc



EN 60598-2-22

Remote controlled

Extraplana

Standard

Non-maintained MULTILED

IP
44

	FINISHING	COM.	LUMEN OUTPUT	AUTONOMY		PACKAGING
F-80L	White	—	90 lm	1 h	0,7	20
F-200L	White	—	220 lm	1 h	0,7	20
F-300L	White	—	350 lm	1 h	0,7	20
F-400L	White	—	400 lm	1 h	0,7	20
F-500L	White	—	500 lm	1 h	0,8	20
F2-200L	White	—	200 lm	2 h	0,7	20
F3-80L	White	—	80 lm	3 h	0,7	20

Maintained / Non-maintained LED

IP
42

	FINISHING	COM.	LUMEN OUTPUT	AUTONOMY		PACKAGING
FL-60	White	—	95 lm	1 h	0,6	20
FL-150	White	—	130 lm	1 h	0,6	20
FL-200	White	—	180 lm	1 h	0,7	20
FL-300	White	—	300 lm	1 h	0,8	20
FL2-200	White	—	275 lm	2 h	0,8	20
FL3-100	White	—	130 lm	3 h	0,8	20



Extraplana

Autotest

Non-maintained MULTILED

IP
44

	FINISHING	COM.	LUMEN OUTPUT	AUTONOMY		PACKAGING
FA-100L	White	—	150 lm	1 h	0,7	20
FA-200L	White	—	220 lm	1 h	0,7	20
FA-300L	White	—	300 lm	1 h	0,7	20
FA-400L	White	—	420 lm	1 h	0,7	20
FA-500L	White	—	520 lm	1 h	0,7	20
FA2-200L	White	—	240 lm	2 h	0,7	20
FA3-100L	White	—	80 lm	3 h	0,8	20

Maintained / Non-maintained LED

IP
42

	FINISHING	COM.	LUMEN OUTPUT	AUTONOMY		PACKAGING
FAL-100	White	—	130 lm	1 h	0,7	20
FAL-200	White	—	210 lm	1 h	0,8	20
FAL-300	White	—	300 lm	1 h	0,8	20
FAL2-200	White	—	300 lm	2 h	0,8	20
FAL3-100	White	—	130 lm	3 h	0,8	20

Intelligent DALI

Compatible with **NormaLINK** 

Non-maintained MULTILED

IP
44

	FINISHING	COM.	LUMEN OUTPUT	AUTONOMY		PACKAGING
FID-100L	White	DALI	100 lm	1 h	0,7	20
FID-200L	White	DALI	220 lm	1 h	0,7	20
FID-300L	White	DALI	350 lm	1 h	0,7	20
FID-400L	White	DALI	400 lm	1 h	0,8	20
FID-500L	White	DALI	500 lm	1 h	0,8	20
FID2-200L	White	DALI	280 lm	2 h	0,7	20
FID3-100L	White	DALI	80 lm	3 h	0,8	20

Maintained / Non-maintained LED

IP
42

	FINISHING	COM.	LUMEN OUTPUT	AUTONOMY		PACKAGING
FIDL-100	White	DALI	100 lm	1 h	0,7	20
FIDL-200	White	DALI	180 lm	1 h	0,8	20
FIDL-300	White	DALI	300 lm	1 h	0,8	20
FIDL2-200	White	DALI	250 lm	2 h	0,8	20
FIDL3-100	White	DALI	100 lm	3 h	0,8	20

Central Battery System

Maintained

IP
42

	FINISHING	POWER SUPPLY	LUMEN OUTPUT	CONSUMPTION	CURRENT		PACKAGING
C24 F-S32L24	White	24 Vcc	300 lm	3,5 W	0,146 A	0,7	20
C24i FI-S32L24	White	24 Vcc	180 lm	7 W	0,292 A	0,6	20
F-S3L	White	230 Vca	210 lm	3,8 W	0,125 A	0,6	20



Extraplana Accessories

Blade diffuser



		PACKAGING
F-DBE	Methacrylate blade diffuser with transparent fixation accessory Recessed assembly with F-ME frame (not included)	20
F-DBL	Methacrylate blade diffuser with transparent clips. Surface mounting	20

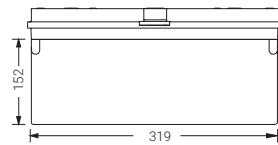

Recession frames

FOR CEILINGS



		PACKAGING
F-ME	Recession frame for EXTRAPLANA series. White colour	20
F-ME-1	Recession frame for EXTRAPLANA series. Anthracite colour	20
F-ME-2	Recession frame for EXTRAPLANA series. Aluminium colour	20
F-ME-M	Metallic recession frame for EXTRAPLANA series	20

F-ME

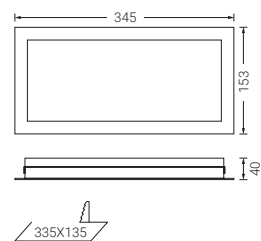

F-ME-M

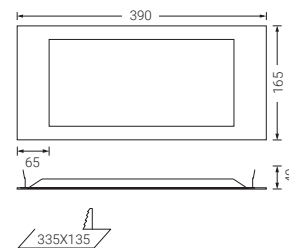

FOR WALLS

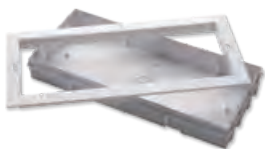

		PACKAGING
F-MEP	Recession frame and box for plasterboard for the EXTRAPLANA range. White colour	20
F-MEP-1	Recession frame and box for EXTRAPLANA series. Anthracite colour	20
F-MEP-2	Recession frame and box for EXTRAPLANA series. Aluminium colour	20
F-MEPL	Wall mounted frame for plasterboard for EXTRAPLANA series	20

F-MEP

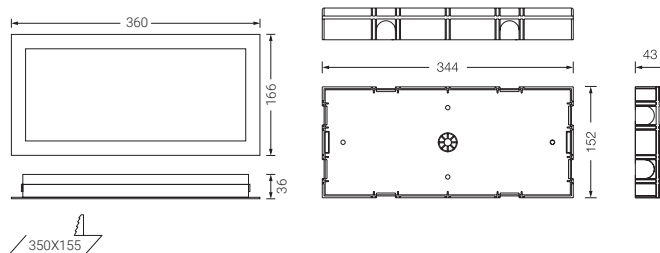

F-MEPL

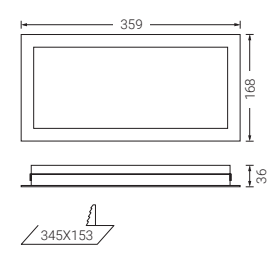

F-MEPL accessorie includes screws to fix the luminaire to the frame for the wall mounted option

Extraplana Accessories

Waterproof box



F-MS

F-MS IP65, IK07 housing

PACKAGING

12

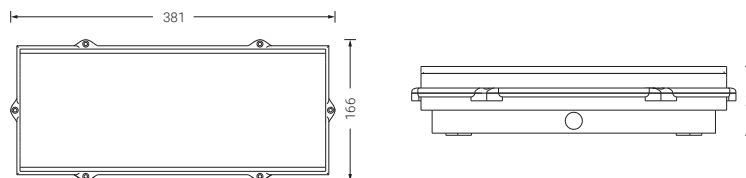

Recession frame for waterproof housing



F-MES

F-MES Recession frame for EXTRAPLANA range when mounted on a waterproof F-MS box

PACKAGING

20

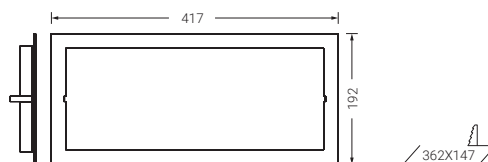

! Watertight and suitable for recession mounted.

Plug in box for tube cable entry

F-CE For metric 20 tube

Bracket for wall installation

U-SBL Bracket for wall installation for EXTRAPLANA range

Remote controls

S-TE Remote control for up to 300 fittings standard or autotest

Pictograms

Type PF Non adhesive pictogram 320 x 150 mm. for F-DBE and F-DBL accessory
References according to table below



Please check for other pictograms

Type PF 320 x 150 mm



Maximum viewing distance (according to EN1838 for internally illuminated signs)

30 m



Lissa

emergency light

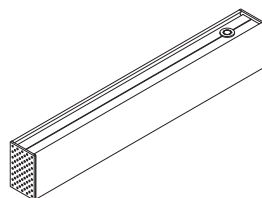
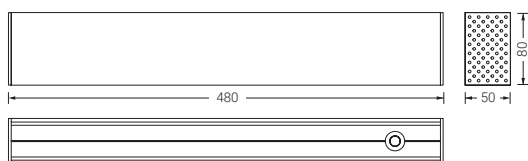
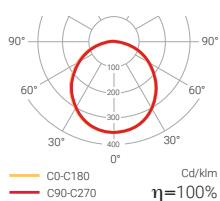

LED



Lm **320**
1-3



Ni-Cd / Ni-MH

IP **20**
 IK **08**

230 Vac
 24 Vdc

EN 60598-2-22

Available also as Exit sign (page 122)

For special luminaires, please contact us

Lissa emergency light

Surface

Standard

Maintained / Non-maintained MULTILED

IP
20

	FINISHING	COM.	LUMEN OUTPUT	AUTONOMY		PACKAGING
LNL-300	White	–	254 lm	1 h	2,2	20
LNL3-300	White	–	254 lm	3 h	2,6	20

Autotest

Maintained / Non-maintained MULTILED

IP
20

	FINISHING	COM.	LUMEN OUTPUT	AUTONOMY		PACKAGING
LNAL-300	White	–	254 lm	1 h	2,2	20
LNAL3-300	White	–	254 lm	3 h	2,6	20

Intelligent DALI

Compatible with **NormaLINK** 

Maintained / Non-maintained MULTILED

IP
20

	FINISHING	COM.	LUMEN OUTPUT	AUTONOMY		PACKAGING
LNIDL-300	White	DALI	254 lm	1 h	2,2	20
LNIDL3-300	White	DALI	254 lm	3 h	2,2	20

Central Battery System

Maintained MULTILED

IP
20

	FINISHING	POWER SUPPLY	LUMEN OUTPUT	CONSUMPTION	CURRENT		PACKAGING
C24 LN-300-S24	White	24 Vcc	254 lm	4 W	0,166 A	1,9	20
C24i LNI-300-S24	White	24 Vcc	254 lm	4 W	0,166 A	1,9	20
LN-300-S	White	230 Vca	254 lm	5 W	0,044 A	1,9	20

Recessed mounting

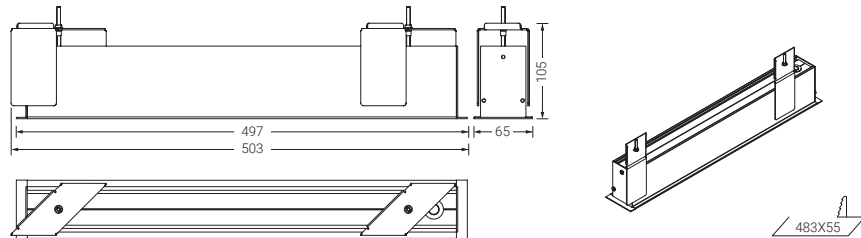

Standard

Maintained / Non-maintained MULTILED

IP 20

	FINISHING	COM.	LUMEN OUTPUT	AUTONOMY		PACKAGING
LNEL-300	White	—	254 lm	1 h	3,3	20
LNEL3-300	White	—	254 lm	3 h	3,6	20

Autotest

Maintained / Non-maintained MULTILED

IP 20

	FINISHING	COM.	LUMEN OUTPUT	AUTONOMY		PACKAGING
LNEAL-300	White	—	254 lm	1 h	3,3	20
LNEAL3-300	White	—	254 lm	3 h	3,6	20

Intelligent DALI

Compatible with **NormaLINK**



Maintained / Non-maintained MULTILED

IP 20

	FINISHING	COM.	LUMEN OUTPUT	AUTONOMY		PACKAGING
LNEIDL-300	White	DALI	254 lm	1 h	3,3	20
LNEIDL3-300	White	DALI	254 lm	3 h	2,8	20



Lissa emergency light recessed mounting

Central Battery System

Maintained MULTILED

IP
20

		FINISHING	POWER SUPPLY	LUMEN OUTPUT	CONSUMPTION	CURRENT		PACKAGING
C24	LNE-300-S24	White	24 Vcc	254 lm	4 W	0,166 A	2,5	20
C24i	LNEI-300-S24	White	24 Vcc	254 lm	4 W	0,166 A	3,0	20
	LNE-300-S	White	230 Vca	254 lm	5 W	0,044 A	3,0	20





Bessel

Maintained / Non-maintained multiled

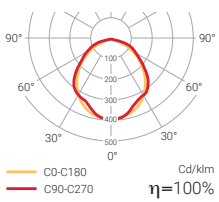

The BESSEL luminaire upgrades the concept of simplicity to a higher level. It is a luminaire designed to meet the basic needs of emergency lighting while keeping a neat look.

Quick assembly

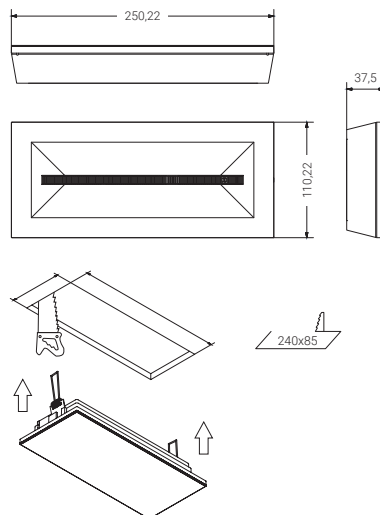

LED



Lm
55-180 **1,5-3**

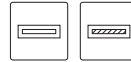

Ni-Cd

IP
42-65 IK
04

230 Vac



EN 60598-2-22

Remote controlled

Bessel

Standard

Non-maintained MULTILED

IP
42

	FINISHING	COM.	LUMEN OUTPUT	AUTONOMY		PACKAGING
L-60L	White	—	60 lm	1,5 h	0,5	20
L-100L	White	—	105 lm	1,5 h	0,6	20
L-150L	White	—	170 lm	1,5 h	0,6	20
L-200L	White	—	180 lm	1,5 h	0,6	20
L3-100L	White	—	75 lm	3 h	0,6	20

IP
65

LE-60L	White	—	60 lm	1,5 h	0,5	20
LE-100L	White	—	105 lm	1,5 h	0,6	20
LE-150L	White	—	170 lm	1,5 h	0,6	20
LE-200L	White	—	180 lm	1,5 h	0,6	20
LE3-100L	White	—	75 lm	3 h	0,6	20

Maintained MULTILED

IP
42

	FINISHING	COM.	LUMEN OUTPUT	AUTONOMY		PACKAGING
LL-60	White	—	55 lm	1,5 h	0,5	20
LL-100	White	—	100 lm	1,5 h	0,6	20
LL-150	White	—	150 lm	1,5 h	0,6	20
LL3-100	White	—	70 lm	3 h	0,6	20

IP
65

LLE-60	White	—	55 lm	1,5 h	0,5	20
LLE-100	White	—	100 lm	1,5 h	0,5	20
LLE-150	White	—	150 lm	1,5 h	0,6	20
LLE3-100	White	—	70 lm	3 h	0,6	20



**WATERTIGHT AND
SUITABLE FOR
RECESSED MOUNTING**

For other versions, please contact us

Accessories

L-FE	Clips for recessed mounting
L-FS	IP65 gasket
L-MEP	Wall mounted recession box. White colour



Volutta

Maintained / Non-maintained led

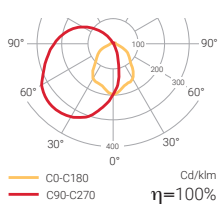

Volutta is the result of mixing equal parts of versatility and style.

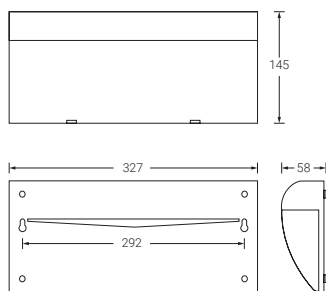

Lm
45-370

1-2-3



Ni-Cd

IP
22

IK
04

230 Vac

24 Vdc



EN 60598-2-22



Remote controlled

Volutta

Standard

Non-maintained MULTILED

IP
22

	FINISHING	COM.	LUMEN OUTPUT	AUTONOMY		PACKAGING
V-50L	White	—	45 lm	1 h	0,6	20
V-50L-1	Anthracite	—	45 lm	1 h	0,6	20
V-50L-2	Aluminium	—	45 lm	1 h	0,6	20
V-75L	White	—	90 lm	1 h	0,6	20
V-75L-1	Anthracite	—	90 lm	1 h	0,6	20
V-75L-2	Aluminium	—	90 lm	1 h	0,6	20
V-170L	White	—	150 lm	1 h	0,6	20
V-170L-1	Anthracite	—	150 lm	1 h	0,6	20
V-170L-2	Aluminium	—	150 lm	1 h	0,6	20
V-300L	White	—	290 lm	1 h	0,7	20
V-300L-1	Anthracite	—	290 lm	1 h	0,7	20
V-300L-2	Aluminium	—	290 lm	1 h	0,7	20
V-400L	White	—	370 lm	1 h	0,7	20
V-400L-1	Anthracite	—	370 lm	1 h	0,7	20
V-400L-2	Aluminium	—	370 lm	1 h	0,7	20

Maintained MULTILED

IP
22

	FINISHING	COM.	LUMEN OUTPUT	AUTONOMY		PACKAGING
VL-60	White	—	60 lm	1 h	0,6	20
VL-60-1	Anthracite	—	60 lm	1 h	0,6	20
VL-60-2	Aluminium	—	60 lm	1 h	0,6	20
VL-200	White	—	285 lm	1 h	0,6	20
VL-200-1	Anthracite	—	285 lm	1 h	0,6	20
VL-200-2	Aluminium	—	285 lm	1 h	0,6	20
VL2-200	White	—	200 lm	2 h	0,7	20
VL2-200-1	Anthracite	—	200 lm	2 h	0,7	20
VL2-200-2	Aluminium	—	200 lm	2 h	0,7	20

Volutta

Autotest

Maintained LED

IP
22

	FINISHING	COM.	LUMEN OUTPUT	AUTONOMY		PACKAGING
VAL-100	White	—	80 lm	1 h	0,6	20
VAL-100-1	Anthracite	—	80 lm	1 h	0,6	20
VAL-100-2	Aluminium	—	80 lm	1 h	0,6	20
VAL-200	White	—	180 lm	1 h	0,6	20
VAL-200-1	Anthracite	—	180 lm	1 h	0,6	20
VAL-200-2	Aluminium	—	180 lm	1 h	0,6	20
VAL3-100	White	—	100 lm	3 h	0,6	20
VAL3-100-1	Anthracite	—	100 lm	3 h	0,6	20
VAL3-100-2	Aluminium	—	100 lm	3 h	0,6	20

Intelligent DALI

Compatible with **NormaLINK** 

Maintained LED

IP
22

	FINISHING	COM.	LUMEN OUTPUT	AUTONOMY		PACKAGING
VIDL-100	White	DALI	80 lm	1 h	0,8	20
VIDL-100-1	Anthracite	DALI	80 lm	1 h	0,8	20
VIDL-100-2	Aluminium	DALI	80 lm	1 h	0,8	20
VIDL-200	White	DALI	200 lm	1 h	0,8	20
VIDL-200-1	Anthracite	DALI	200 lm	1 h	0,8	20
VIDL-200-2	Aluminium	DALI	200 lm	1 h	0,8	20
VIDL3-100	White	DALI	100 lm	3 h	0,8	20
VIDL3-100-1	Anthracite	DALI	100 lm	3 h	0,8	20
VIDL3-100-2	Aluminium	DALI	100 lm	3 h	0,8	20

Central Battery System

Maintained LED

IP
22

	FINISHING	POWER SUPPLY	LUMEN OUTPUT	CONSUMPTION	CURRENT		PACKAGING
C24 V-S3L24	White	24 Vcc	250 lm	6,0 W	0,250 A	0,6	20
V-S3L	White	230 Vca	250 lm	6,0 W	0,069 A	0,6	20

Volutta Accessories

Remote controls



Compatible with all the VOLUTTA range

S-TE Remote control for up to 300 fittings Standard or autotest

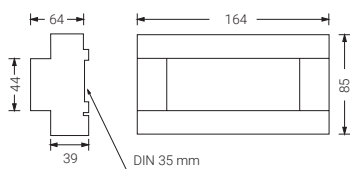

Pictograms

Type PN Adhesive pictogram 300 x 130 mm. *References according to table below*

Type PN 300 x 130 mm



Maximum viewing distance (according to EN1838 for internally illuminated signs)

26 m

 Please check for other pictograms





Volutta doble

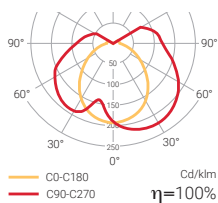

VOLUTTA DOBLE is an emergency luminaire that offers numerous possibilities for installation. It can be mounted on the ceiling or suspended from the ceiling/wall using an accessory.

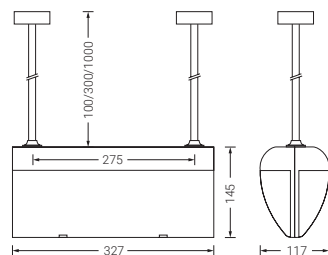

Lm
60-310

1-2-3



Ni-Cd

IP
22

IK
04

230 Vac



EN 60598-2-22



Remote controlled

Volutta doble

Standard

Non-maintained MULTILED

IP

22

	FINISHING	COM.	LUMEN OUTPUT	AUTONOMY		PACKAGING
VD-75L	White	—	75 lm	1 h	1,0	10
VD-75L-1	Anthracite	—	75 lm	1 h	1,0	10
VD-75L-2	Aluminium	—	75 lm	1 h	1,0	10
VD-300L	White	—	290 lm	1 h	1,0	10
VD-300L-1	Anthracite	—	290 lm	1 h	1,0	10
VD-300L-2	Aluminium	—	290 lm	1 h	1,0	10
VD3-75L	White	—	80 lm	3 h	0,9	10
VD3-75L-1	Anthracite	—	80 lm	3 h	0,9	10
VD3-75L-2	Aluminium	—	80 lm	3 h	0,9	10

Maintained MULTILED

IP

22

	FINISHING	COM.	LUMEN OUTPUT	AUTONOMY		PACKAGING
VDL-60	White	—	60 lm	1 h	1,1	10
VDL-60-1	Anthracite	—	60 lm	1 h	1,1	10
VDL-60-2	Aluminium	—	60 lm	1 h	1,1	10
VDL-200	White	—	310 lm	1 h	1,2	10
VDL-200-1	Anthracite	—	310 lm	1 h	1,2	10
VDL-200-2	Aluminium	—	310 lm	1 h	1,2	10
VDL2-200	White	—	200 lm	2 h	1,2	10
VDL2-200-1	Anthracite	—	200 lm	2 h	1,2	10
VDL2-200-2	Aluminium	—	200 lm	2 h	1,2	10

Volutta doble Accessories

Wall and ceiling mounting accessories



VKS



V-C

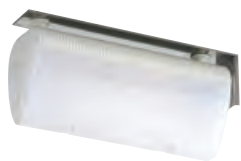

VDSB

VKS-100	1000 mm. ceiling suspension. White colour
VKS-100-1	1000 mm. ceiling suspension. Anthracite colour
VKS-100-2	1000 mm. ceiling suspension. Aluminium colour
VKS-30	300 mm. ceiling suspension. White colour
VKS-30-1	300 mm. ceiling suspension. Anthracite colour
VKS-30-2	300 mm. ceiling suspension. Aluminium colour
V-C	100 mm ceiling suspension. White colour
V-C-1	100 mm ceiling suspension. Anthracite colour
V-C-2	100 mm ceiling suspension. Aluminium colour
V-DSB	Suspension with wall bracket. White colour
V-DSB-1	Suspension with wall bracket. Anthracite colour
V-DSB-2	Suspension with wall bracket. Aluminium colour

Remote controls



S-TE Remote control for up to 300 fittings standard or autotest

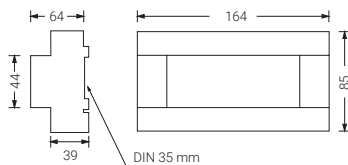





Volutta

recessed mounting

Maintained led

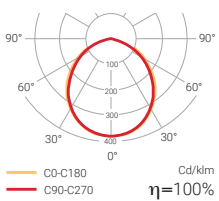

Non-maintained led

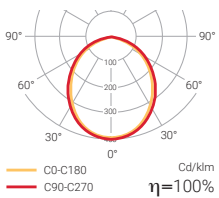

CE 850°C LED



Lm
80-500

1-2-3



IP
42-44

IK
04



EN 60598-2-22

! Quick assembly

+ Remote controlled

Volutta recessed mounting

WALL MOUNTING

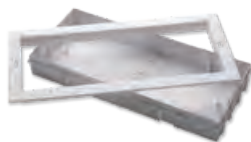

Box for wall mounting (supplied with rear box for recession)

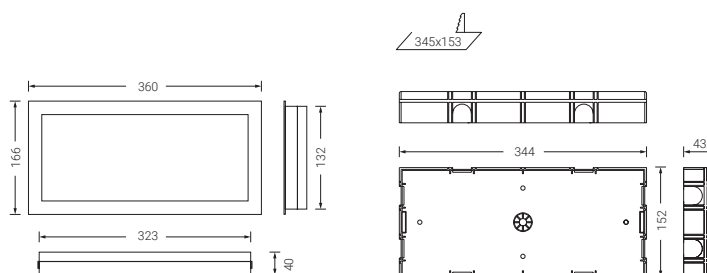

Standard

Non-maintained MULTILED

IP 44

	FINISHING	COM.	LUMEN OUTPUT	AUTONOMY		PACKAGING
VP-80L	White	—	90 lm	1 h	1,5	20
VP-80L-1	Anthracite	—	90 lm	1 h	1,5	20
VP-80L-2	Aluminium	—	90 lm	1 h	1,5	20
VP-200L	White	—	220 lm	1 h	1,5	20
VP-200L-1	Anthracite	—	220 lm	1 h	1,5	20
VP-200L-2	Aluminium	—	220 lm	1 h	1,5	20
VP-300L	White	—	350 lm	1 h	1,6	20
VP-300L-1	Anthracite	—	350 lm	1 h	1,6	20
VP-300L-2	Aluminium	—	350 lm	1 h	1,6	20
VP-400L	White	—	400 lm	1 h	1,6	20
VP-400L-1	Anthracite	—	400 lm	1 h	1,6	20
VP-400L-2	Aluminium	—	400 lm	1 h	1,6	20
VP-500L	White	—	500 lm	1 h	1,6	20
VP-500L-1	Anthracite	—	500 lm	1 h	1,6	20
VP-500L-2	Aluminium	—	500 lm	1 h	1,6	20
VP2-200L	White	—	200 lm	2 h	1,6	20
VP2-200L-1	Anthracite	—	200 lm	2 h	1,6	20
VP2-200L-2	Aluminium	—	200 lm	2 h	1,6	20
VP3-80L	White	—	80 lm	3 h	1,5	20
VP3-80L-1	Anthracite	—	80 lm	3 h	1,5	20
VP3-80L-2	Aluminium	—	80 lm	3 h	1,5	20

Maintained / Non-maintained LED

IP 42

	FINISHING	COM.	LUMEN OUTPUT	AUTONOMY		PACKAGING
VPL-60	White	—	95 lm	1 h	0,9	20
VPL-60-1	Anthracite	—	95 lm	1 h	0,9	20
VPL-60-2	Aluminium	—	95 lm	1 h	0,9	20
VPL-150	White	—	130 lm	1 h	0,9	20
VPL-150-1	Anthracite	—	130 lm	1 h	0,9	20
VPL-150-2	Aluminium	—	130 lm	1 h	0,9	20
VPL-200	White	—	180 lm	1 h	1,0	20
VPL-200-1	Anthracite	—	180 lm	1 h	1,0	20
VPL-200-2	Aluminium	—	180 lm	1 h	1,0	20
VPL2-200	White	—	180 lm	2 h	1,2	20
VPL2-200-1	Anthracite	—	180 lm	2 h	1,2	20
VPL2-200-2	Aluminium	—	180 lm	2 h	1,2	20
VPL3-100	White	—	100 lm	3 h	1,0	20
VPL3-100-1	Anthracite	—	100 lm	3 h	1,0	20
VPL3-100-2	Aluminium	—	100 lm	3 h	1,0	20

Volutta recessed mounting

CEILING MOUNTING

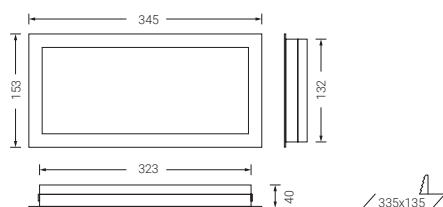

Standard

Non-maintained MULTILED

IP
44

	FINISHING	COM.	LUMEN OUTPUT	AUTONOMY		PACKAGING
VT-80L	White	—	90 lm	1 h	0,8	20
VT-80L-1	Anthracite	—	90 lm	1 h	0,8	20
VT-80L-2	Aluminium	—	90 lm	1 h	0,8	20
VT-200L	White	—	220 lm	1 h	0,8	20
VT-200L-1	Anthracite	—	220 lm	1 h	0,8	20
VT-200L-2	Aluminium	—	220 lm	1 h	0,8	20
VT-300L	White	—	350 lm	1 h	0,9	20
VT-300L-1	Anthracite	—	350 lm	1 h	0,9	20
VT-300L-2	Aluminium	—	350 lm	1 h	0,9	20
VT-400L	White	—	400 lm	1 h	0,9	20
VT-400L-1	Anthracite	—	400 lm	1 h	0,9	20
VT-400L-2	Aluminium	—	400 lm	1 h	0,9	20
VT-500L	White	—	500 lm	1 h	1,0	20
VT-500L-1	Anthracite	—	500 lm	1 h	1,0	20
VT-500L-2	Aluminium	—	500 lm	1 h	1,0	20
VT2-200L	White	—	200 lm	2 h	0,9	20
VT2-200L-1	Anthracite	—	200 lm	2 h	0,9	20
VT2-200L-2	Aluminium	—	200 lm	2 h	0,9	20
VT3-80L	White	—	80 lm	3 h	0,8	20
VT3-80L-1	Anthracite	—	80 lm	3 h	0,8	20
VT3-80L-2	Aluminium	—	80 lm	3 h	0,8	20

Maintained LED

IP
42

	FINISHING	COM.	LUMEN OUTPUT	AUTONOMY		PACKAGING
VTL-60	White	—	95 lm	1 h	0,8	20
VTL-60-1	Anthracite	—	95 lm	1 h	0,8	20
VTL-60-2	Aluminium	—	95 lm	1 h	0,8	20
VTL-150	White	—	130 lm	1 h	0,8	20
VTL-150-1	Anthracite	—	130 lm	1 h	0,8	20
VTL-150-2	Aluminium	—	130 lm	1 h	0,8	20
VTL-200	White	—	180 lm	1 h	0,9	20
VTL-200-1	Anthracite	—	180 lm	1 h	0,9	20
VTL-200-2	Aluminium	—	180 lm	1 h	0,9	20
VTL2-200	White	—	180 lm	2 h	0,9	20
VTL2-200-1	Anthracite	—	180 lm	2 h	0,9	20
VTL2-200-2	Aluminium	—	180 lm	2 h	0,9	20
VTL3-100	White	—	100 lm	3 h	0,9	20
VTL3-100-1	Anthracite	—	100 lm	3 h	0,9	20
VTL3-100-2	Aluminium	—	100 lm	3 h	0,9	20

Volutta recessed mounting

Central Battery System

Maintained LED

IP 42

	FINISHING	POWER SUPPLY	LUMEN OUTPUT	CONSUMPTION	CURRENT	PACKAGING
VT-S3L	White	230 Vca	250 lm	3,8 W	0,069 A	20

Accessories

Blade diffuser



		PACKAGING
F-DBE	Blade diffuser with transparent fixing accessory . Embedded mounted with F-ME accessory (not included).	20

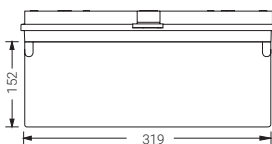

Remote controls



Compatible with all the VOLUTTA range

S-TE	Remote control for up to 300 fittings standard or autotest
-------------	--

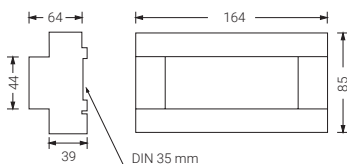

Pictograms

Type PF Non adhesive pictogram 320 x 150 mm for F-DBE and F-DBL accessories
References according to table below

Type PN Adhesive pictogram 300 x 130 mm. *References according to table below*

Type PF 320 x 150 mm



Maximum viewing distance (according to EN1838 for internally illuminated signs)

30 m

Type PN 300 x 130 mm



Maximum viewing distance (according to EN1838 for internally illuminated signs)

26 m

Please check for other pictograms



Now
with LiFePO4
lithium batteries

Excellence

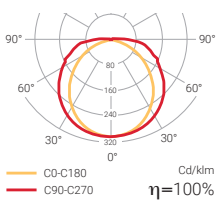

! Quick assembly

The EXCELLENCE emergency fittings are our bet on design and functionality. They are luminaires that are fully made from polycarbonate with stylish shapes that make them ideal for mounting on the wall/ ceiling or recessed mounting.

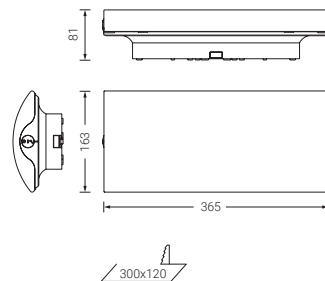

Lm
110-330

1-2-3



Ni-Cd
LiFePO4

IP
42

IK
04

230 Vac
24 Vdc



EN 60598-2-22

+ Remote controlled

Excellence

Standard

Non-maintained MULTILED

IP
42

	FINISHING	COM.	LUMEN OUTPUT	AUTONOMY		PACKAGING
E-200L	White	—	200 lm	1 h	1,1	12
E-300L	White	—	300 lm	1 h	1,1	12

Autotest



Non-maintained MULTILED

IP
42

	FINISHING	COM.	LUMEN OUTPUT	AUTONOMY		PACKAGING
EA-200L	White	—	180 lm	1 h	1,1	12
EA-300L	White	—	300 lm	1 h	1,2	12

Maintained / Non-maintained MULTILED

IP
42

	FINISHING	COM.	LUMEN OUTPUT	AUTONOMY		PACKAGING
EAL-200M	White	—	180 lm	1 h	1,1	12
EAL-250M	White	—	250 lm	1 h	1,1	12
LITHIUM EAL-250LI	White	—	240 lm	1 h	1,1	12
EAL-300M	White	—	330 lm	1 h	1,2	12
LITHIUM EAL3-100M	White	—	110 lm	3 h	1,1	12
LITHIUM EAL3-250LI	White	—	240 lm	3 h	1,2	12

Intelligent DALI

Compatible with **NormaLINK** 

Maintained / Non-maintained MULTILED

IP
42

	FINISHING	COM.	LUMEN OUTPUT	AUTONOMY		PACKAGING
LITHIUM EIDL-250M	White	DALI	250 lm	1 h	1,1	12
LITHIUM EIDL-250LI	White	DALI	240 lm	1 h	1,2	12
EIDL-300M	White	DALI	330 lm	1 h	1,2	12
LITHIUM EIDL3-100M	White	DALI	110 lm	3 h	1,1	12
LITHIUM EIDL3-250LI	White	DALI	240 lm	3 h	1,2	12

Intelligent Wireless



New

Maintained / Non-maintained MULTILED

IP
42

	FINISHING	COM.	LUMEN OUTPUT	AUTONOMY		PACKAGING
EIDL-300M-R	White	DALI	330 lm	1 h	1,2	12
EIDL3-100M-R	White	DALI	110 lm	3 h	1,1	12

Central Battery System

Maintained MULTILED

IP
42

	FINISHING	POWER SUPPLY	LUMEN OUTPUT	CONSUMPTION	CURRENT		PACKAGING
C24 E-S24L24	White	24 Vcc	306 lm	2,64 W	0,11 A	1,0	12
C24i EI-S25L24	White	24 Vcc	240 lm	3 W	0,125 A	1,1	12
E-S24L	White	230 Vca	320 lm	3,7 W	0,019 A	1,2	12

Excellence Accessories

**FALSE CEILING RECESSED
MOUNTING** (accessory included)



SURFACE MOUNTING
(accessory included)



Tube cable entry

O-AT M20 tube mounting accessory.
Adapter included free of charge.

Minitrunking
cable entry

The fitting has three entries for minitrunking, 20 x 10mm

Recession frames

This fitting does not require any recession frame.
Two metal clips are supplied with it free of charge

Aluminium frame



E-MD Improves the aesthetics making it more modern.
It is needed for the installation of the non adhesive pictogram.

Light orientator



E-OL Aluminium sheet to be installed over the diffuser and direct the light
to the flag diffuser, avoiding the glare

Excellence Accessories

Wall and ceiling mounting accessories



O-KS 30/100

OKS-30	300 mm metal rod for ceiling suspension
OKS-100	1000 mm metal rod for ceiling suspension
E-SBT	Ceiling accessory
E-SB	Wall accessory



E-SB

Remote controls

S-TE	Remote control for up to 300 fittings standard or autotest
-------------	--

Check other control options on page 158

Serigraphed methacrylate blade diffusers



E-DB	E-DB transparent blade diffuser (includes the clips for installation) PAB type pictogram included
-------------	--

The methacrylate pictograms are offered with the wall fixation bracket. The transparent blade diffuser (Ref: E-DB) can also be used with any of the adhesives for any other use

Type PAB 350 x 150 mm	Maximum viewing distance (according to EN1838 for internally illuminated signs) 30 m		
REF. PAB-A	REF. PAB-A	REF. PAB-SD	REF. PAB-SU

Pictograms

Type PAM	Non adhesive pictogram 350x168 mm. To be used on the E-MD accessorie (not included)
Type PE	Adhesive pictogram 355 x 150 mm to be placed on the cover of the emergency light

Type PAM 350 x 168 mm	Maximum viewing distance (according to EN1838 for internally illuminated signs) 36 m		
REF. PAM-L	REF. PAM-R	REF. PAM-SD	REF. PAM-SU

Type PE 355 x 150 mm			
REF. PE-L	REF. PE-R	REF. PE-SD	REF. PE-SU

Please check for other pictograms



Now
with LiFePO4
lithium batteries

Euoprisma

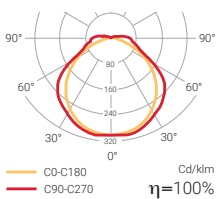

The emergency fittings from the EUROPRISMA range have been designed to guarantee function in the most challenging installations. Their IP65 rating combined with a wide range of products make them the ideal choice for industrial installations.

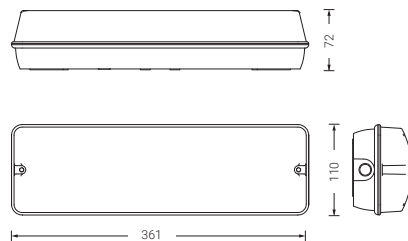

! Low temperature versions on page 99

! Available with lithium battery

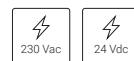

Europrisma

Standard

Non-maintained MULTILED

IP
65

	FINISHING	COM.	LUMEN OUTPUT	AUTONOMY		PACKAGING
EH-200L	White	—	200 lm	1 h	0,7	20
EH-300L	White	—	300 lm	1 h	0,7	20
EH3-100L	White	—	100 lm	3 h	0,7	20

Maintained / Non-maintained MULTILED

IP
65

	FINISHING	COM.	LUMEN OUTPUT	AUTONOMY		PACKAGING
EHL-200M	White	—	250 lm	1 h	0,7	20
EHL3-100M	White	—	110 lm	3 h	0,7	20

Autotest

Maintained / Non-maintained LED

IP
65

	FINISHING	COM.	LUMEN OUTPUT	AUTONOMY		PACKAGING
LITHIUM EHAL-250LI	White	—	240 lm	1 h	0,6	20
LITHIUM EHAL-500LI	White	—	500 lm	1 h	0,8	20
LITHIUM EHAL3-250LI	White	—	240 lm	3 h	0,7	20

Maintained / Non-maintained MULTILED

IP
65

	FINISHING	COM.	LUMEN OUTPUT	AUTONOMY		PACKAGING
EHAL-200M	White	—	240 lm	1 h	0,7	20
EHAL3-100M	White	—	110 lm	3 h	0,7	20

Europrisma

Intelligent DALI

Compatible with **NormaLINK**

Maintained / Non-maintained MULTILED

IK 10 IP 65

	FINISHING	COM.	LUMEN OUTPUT	AUTONOMY		PACKAGING	
LITHIUM	EHIDL-200M	White	DALI	270 lm	1 h	0,7	20
	EHIDL-250LI	White	DALI	240 lm	1 h	0,7	20
LITHIUM	EHIDL3-100M	White	DALI	110 lm	3 h	0,7	20
	EHIDL3-250LI	White	DALI	240 lm	3 h	0,7	20

Intelligent Wireless



New

Maintained / Non-maintained MULTILED

IK 10 IP 65

	FINISHING	COM.	LUMEN OUTPUT	AUTONOMY		PACKAGING	
	EHIDL-200M-R	White	DALI	270 lm	1 h	0,7	20
	EHIDL3-100M-R	White	DALI	110 lm	3 h	0,7	20

Central Battery System

Maintained MULTILED

IP 65

	FINISHING	POWER SUPPLY	LUMEN OUTPUT	CONSUMPTION	CURRENT		PACKAGING	
C24	EH-S24L24	White	24 Vcc	290 lm	2,9 W	0,121 A	0,6	20
C24i	EHI-S25L24	White	24 Vcc	240 lm	3 W	0,125 A	0,7	20
	EH-S25L	White	230 Vca	270 lm	2,7 W	0,015 A	0,7	20

Emergency lighting

Europrisma

Emergency light adapted to the cold



New

Refrigerating chambers, ship's holds, high mountain cabins.... standard general lighting is not design for such situations.

Europrisma is the emergency lighting created to achieve its optimal performance and to ensure the safety with extreme temperatures.

Working temperature up to -25°C

Maintained / Non-maintained MULTILED



	FINISHING	COM.	LUMEN OUTPUT	AUTONOMY		PACKAGING
EHIDL-200C	White	DALI	240 lm	1 h	0,7	20
EHIDL-400C	White	DALI	400 lm	1 h	0,7	20



NORMALUX

Emergency lighting
normalux.com



Normagrup

Sense of Technology

Europrisma Accessories

Blade diffuser



EH-DB Flag diffuser for all the fittings of the Europrisma range

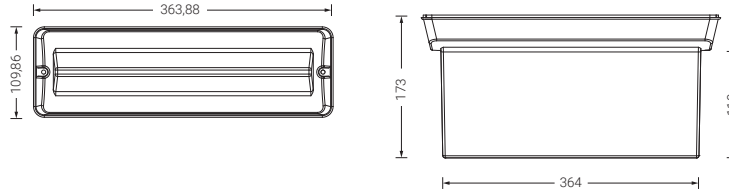

Recession frames



EH-ME Recession frame for the EUROPRISMA series

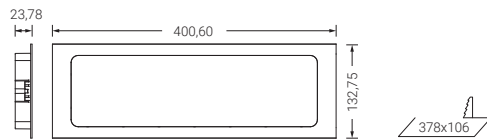

! Watertight and suitable for recession mounted

Wall and ceiling brackets

E-SB Bracket for wall mounting
E-SBT Bracket for ceiling mounting

Remote controls



S-TE Remote control for up to 300 fittings standard or autotest

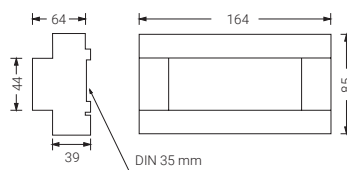

Pictograms



Type PM Internal pictogram 300 x 100 mm. *References according to table below*

Type PM 300 x 100 mm



Maximum viewing distance (according to EN1838 for internally illuminated signs)

20 m

! Please check for other pictograms





Uro

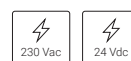
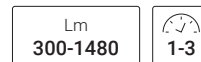
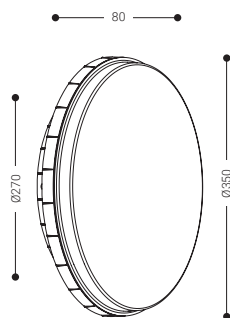
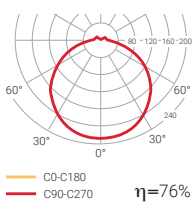

! Two mounting possibilities:
Wall or ceiling

! Up to 1750 lumen output in
maintained mode

+ Able to be used with a remote control

Uro

Standard

Maintained / Non-maintained MULTILED

IP 65

	FINISHING	COM.	LUMEN OUTPUT DURING MAINS	LUMEN OUTPUT IN EMERGENCY	AUTONOMY		PACKAGING
UL-300	White	—	920 lm	300 lm	1 h	1,5	8
UL-700	White	—	1750 lm	710 lm	1 h	1,6	8
UL3-500	White	—	1710 lm	500 lm	3 h	2,3	20

Autotest

Maintained / Non-maintained MULTILED

IP 65

	FINISHING	COM.	LUMEN OUTPUT DURING MAINS	LUMEN OUTPUT IN EMERGENCY	AUTONOMY		PACKAGING
UAL-700	White	—	1750 lm	710 lm	1 h	0,7	20
UAL3-500	White	—	1710 lm	500 lm	3 h	0,7	20

Intelligent DALI

Compatible with **NormaLINK** 



Maintained / Non-maintained MULTILED

IP 65

	FINISHING	COM.	LUMEN OUTPUT DURING MAINS	LUMEN OUTPUT IN EMERGENCY	AUTONOMY		PACKAGING
UIDL-700	White	DALI	1750 lm	710 lm	1 h	1,6	20
UIDL3-500	White	DALI	1710 lm	500 lm	3 h	2,3	20

Central Battery System

Maintained LED

IP 65

	FINISHING	POWER SUPPLY	LUMEN OUTPUT	CONSUMPTION	CURRENT		PACKAGING	
C24	UL-S2L24	White	24 Vcc	1480 lm	14,9 W	0,065 A	1,3	8
C24i	UIL-S2L24	White	24 Vcc	1480 lm	14,9 W	0,065 A	1,3	8





Hermetic XL

Maintained / Non-maintained multiled

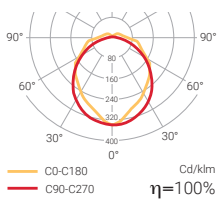

HERMETIC XL is a waterproof (IP66) luminaire ideal for basements, garages or any industrial activity. Specifically designed with LED technology, it incorporates the new and revolutionary quick installation system which improves installation time and optimises maintenance work.

CE 850°C LED

Lm
1330-1960

1

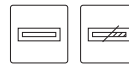

Ni-MH

IP
66

IK
10

230 Vac

24 Vdc



EN 60598-2-22

! Quick installation system

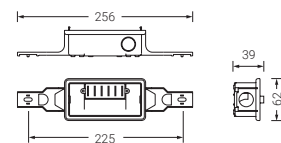
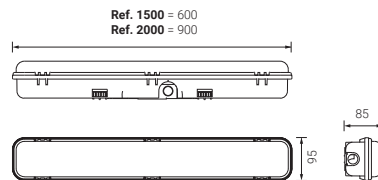

Base enchufable

! Quick assembly

+ Remote controlled

Hermetic XL

Standard

Non-maintained MULTILED

IP
66

	FINISHING	COM.	LUMEN OUTPUT	AUTONOMY		PACKAGING
DE-1500L	Grey	—	1330 lm	1 h	1,4	1
DE-2000L	Grey	—	1960 lm	1 h	2,3	1

127v 50/60Hz also available upon request. Indicate reference + V

Maintained / Non-maintained MULTILED

IP
66

	FINISHING	COM.	LUMEN OUTPUT	AUTONOMY		PACKAGING
DEL-1500	Grey	—	1330 lm	1 h	2,1	1
DEL-2000	Grey	—	1960 lm	1 h	2,9	1

127v 50/60Hz also available upon request. Indicate reference + V

Autotest

Non-maintained MULTILED

IP
66

	FINISHING	COM.	LUMEN OUTPUT	AUTONOMY		PACKAGING
DEA-1500L	Grey	—	1330 lm	1 h	2,1	1
DEA-2000L	Grey	—	1960 lm	1 h	2,9	1

127v 50/60Hz also available upon request. Indicate reference + V

Maintained / Non-maintained MULTILED

IP
66

	FINISHING	COM.	LUMEN OUTPUT	AUTONOMY		PACKAGING
DEAL-1500	Grey	—	1330 lm	1 h	2,1	1
DEAL-2000	Grey	—	1960 lm	1 h	2,9	1

127v 50/60Hz also available upon request. Indicate reference + V

Intelligent DALI

Compatible with **NormaLINK** 

Non-maintained MULTILED

IP
66

	FINISHING	COM.	LUMEN OUTPUT	AUTONOMY		PACKAGING
DEID-1500L	Grey	DALI	1330 lm	1 h	2,1	1
DEID-2000L	Grey	DALI	1960 lm	1 h	2,0	1



127v 50/60Hz also available upon request. Indicate reference + V

Maintained / Non-maintained MULTILED

IP
66

	FINISHING	COM.	LUMEN OUTPUT	AUTONOMY		PACKAGING
DEIDL-1500	Grey	DALI	1330 lm	1 h	2,1	1
DEIDL-2000	Grey	DALI	1960 lm	1 h	2,9	1

127v 50/60Hz also available upon request. Indicate reference + V

 Please ask for the references with remote control option For other durations, please contact us

Accessories

Remote controls

S-TE Remote control for up to 300 fittings standard or autotest



Aura

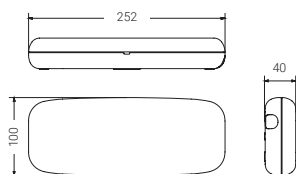
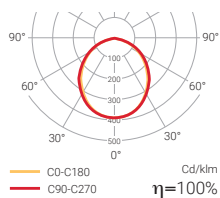

CE 850°C LED



Lm
57-355

1-2



IP
44

IK
04



EN 60598-2-22



Remote controlled

Standard

Non-maintained LED

IP
44

	FINISHING	COM.	LUMEN OUTPUT	AUTONOMY		PACKAGING
A-60L	White	—	57 lm	1 h	0,4	30
A-100L	White	—	105 lm	1 h	0,4	30
A-150L	White	—	135 lm	1 h	0,4	30
A-200L	White	—	175 lm	1 h	0,4	30
A-300L	White	—	310 lm	1 h	0,4	30
A-400L	White	—	355 lm	1 h	0,4	30
A2-200L	White	—	200 lm	2 h	0,4	30

Available in 127v AC 50/60Hz. Indicate reference + V.
Available in 24v DC. Indicate reference + C.



Aura 65

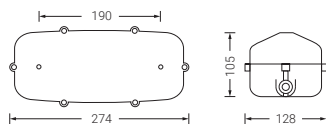
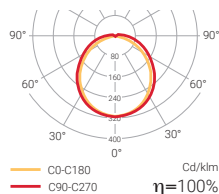

CE 850°C LED



Lm
57-355

1-2



IP **65** IK **07**



EN 60598-2-22



Remote controlled

Standard

Non-maintained LED

IP **65**

	FINISHING	COM.	LUMEN OUTPUT	AUTONOMY		PACKAGING
AE-60L	White	—	57 lm	1 h	0,6	20
AE-100L	White	—	105 lm	1 h	0,6	20
AE-150L	White	—	135 lm	1 h	0,6	20
AE-200L	White	—	175 lm	1 h	0,6	20
AE-300L	White	—	310 lm	1 h	0,7	20
AE-400L	White	—	355 lm	1 h	0,7	20
AE2-200L	White	—	240 lm	2 h	0,7	20

Available in 127v AC 50/60Hz. Indicate reference + V.
Available in 24v DC. Indicate reference + C.

Aura and Aura 65 Accessories

Recession frames

		PACKAGING
A-ME	Recession frame for AURA series fittings	20

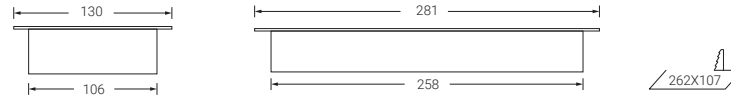

 Only compatible with Aura series fittings

Remote controls

S-TE	Remote control for up to 300 fittings standard or autotest
-------------	--

Pictograms

Type N	Adhesive pictogram 150 x 90 mm. <i>References according to table below</i>
---------------	--

Type N 150 x 90 mm



Maximum viewing distance
(according to EN1838 for
internally illuminated signs)

18 m

 Please check for other pictograms





Watertight self-contained fittings

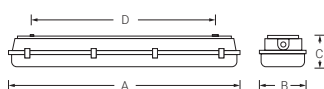

	A	B	C	D
1x18	680	105	120	500
2x18	680	175	120	500
1x36	1.280	105	120	912
2x36	1.280	175	120	912
1x58	1.600	105	120	995
2x58	1.600	175	120	995

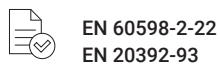
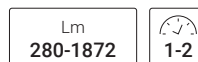

Watertight self-contained fittings

IP 65

	DESCRIPTION	LUMEN OUTPUT	AUTONOMY
MES2FL36C	2 x 36 fitting – 1 maintained + 1 emergency	837 lm	1 h
MESFL36	1 x 36 fitting – emergency	837 lm	1 h
MES2FL36P	2 x 36 fitting – 2 maintained + 1 emergency	837 lm	1 h
MESFL36P	1 x 36 fitting – maintained + emergency	837 lm	1 h
MES2FL58C	2 x 58 fitting – 1 maintained + 1 emergency	936 lm	1 h
MESFL58	1 x 58 fitting – emergency	936 lm	1 h
MES2FL58P	2 x 58 fitting – 2 maintained + 1 emergency	936 lm	1 h
MESFL58P	1 x 58 fitting – maintained + emergency	936 lm	1 h
MES2FL36	2 x 36 fitting – 2 emergency	1674 lm	1 h
MES2FL36P2E	2 x 36 fitting – 2 maintained + 2 emergency	1674 lm	1 h
MES2FL58	2 x 58 fitting – 2 emergency	1872 lm	1 h
MES2FL58P2E	2 x 58 fitting – 2 maintained + 2 emergency	1872 lm	1 h
MES2FL18C	2 x 18 fitting – 1 maintained + 1 emergency	526 lm	2 h
MESFL18	1 x 18 fitting – emergency	526 lm	2 h
MESFL18P	1 x 18 fitting – maintained + emergency	526 lm	2 h
MES2FL18	2 x 18 fitting – 2 emergency	1052 lm	2 h
MES2FL18P	2 x 18 fitting – 2 maintained + 1 emergency	1052 lm	2 h
MES2FL18P2E	2 x 18 fitting – 2 maintained + 2 emergency	280 lm	2 h

Accessories

Remote controls

S-TE Remote control for up to 300 fittings standard or autotest

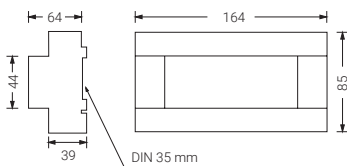

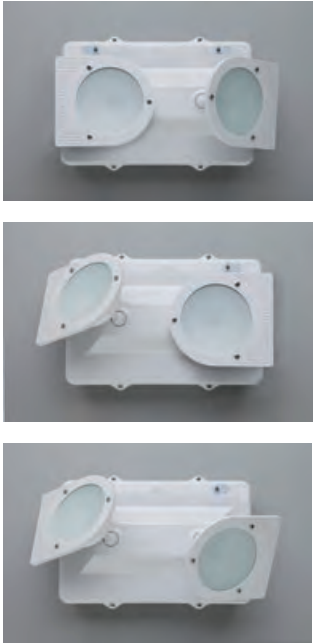

Now
maintained standard,
autotest or DALI.

Dopplo



Some versions compliant
with French Regulation

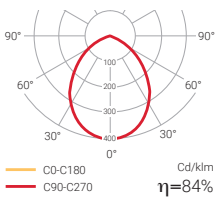

! Quick assembly

The DOPPLO emergency fittings have been designed to cover large surfaces in spaces that require an aesthetic design. Made with a polycarbonate housing, they form wide light range that makes them versatile fittings for large and medium-sized spaces (large halls, pavilions, sports centres etc.).

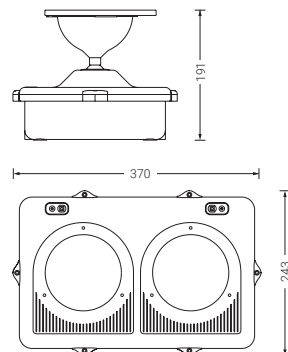
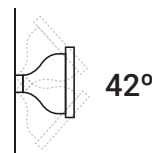

-
-
- Lm
1000-3500

1-2-3
-
-
-
- IP **65**

IK **07**
- 230 Vac

24 Vdc
-
- EN 60598-2-22**

+ Remote controlled

Dopplo

Standard

Non-maintained LED

IP
65

	FINISHING	COM.	LUMEN OUTPUT	AUTONOMY		PACKAGING
DO-1100L	Grey	—	1040 lm	1 h	5,2	1
DO-1900L	Grey	—	1850 lm	1 h	5,9	1
DO-2400L	Grey	—	2300 lm	1 h	6,3	1
DO-3000L	Grey	—	3500 lm	1 h	7,2	1
DO2-1900L	Grey	—	1850 lm	2 h	6,3	1
DO3-1000L	Grey	—	1000 lm	3 h	6,3	1

127V 50/60Hz 24Vcc also available upon request. Indicate reference + V.

Maintained / Non-maintained LED

IP
65

	FINISHING	COM.	LUMEN OUTPUT	AUTONOMY		PACKAGING
N DOL-1900	Grey	—	1850 lm	1 h	5,8	1

127V 50/60Hz 24Vcc also available upon request. Indicate reference + V.

Autotest

Non-maintained LED

IP
65

	FINISHING	COM.	LUMEN OUTPUT	AUTONOMY		PACKAGING
DOA-1100L	Grey	—	1040 lm	1 h	5,2	1
DOA-1900L	Grey	—	1850 lm	1 h	5,9	1
DOA-2400L	Grey	—	2300 lm	1 h	6,3	1
DOA-3000L	Grey	—	3500 lm	1 h	7,2	1
DOA2-1900L	Grey	—	1950 lm	2 h	7,2	1
DOA3-1000L	Grey	—	1000 lm	3 h	7,0	1

127V 50/60Hz 24Vcc also available upon request. Indicate reference + V.

Maintained / Non-maintained LED

IP
65

	FINISHING	COM.	LUMEN OUTPUT	AUTONOMY		PACKAGING
N DOAL-1900	Grey	—	1850 lm	1 h	5,8	1

127V 50/60Hz 24Vcc also available upon request. Indicate reference + V.

Dopplo

Intelligent DALI

Compatible with **NormaLINK**



Non-maintained LED

IP 65

	FINISHING	COM.	LUMEN OUTPUT	AUTONOMY		PACKAGING
DOID-1100L	Grey	DALI	1040 lm	1 h	5,3	1
DOID-1900L	Grey	DALI	2100 lm	1 h	6,0	1
DOID-2400L	Grey	DALI	2070 lm	1 h	6,4	1
DOID-3000L	Grey	DALI	3500 lm	1 h	6,4	1
DOID2-1900L	Grey	DALI	1850 lm	2 h	8,9	1
DOID3-1000L	Grey	DALI	1000 lm	3 h	6,4	1

127V 50/60Hz 24Vcc also available upon request. Indicate reference + V.

Maintained / Non-maintained LED

IP 65



	FINISHING	COM.	LUMEN OUTPUT	AUTONOMY		PACKAGING
DOIDL-1900	Grey	DALI	1850 lm	1 h	4,8	1

127V 50/60Hz 24Vcc also available upon request. Indicate reference + V.

Central Battery System

Maintained LED

IP 65



C24i

	FINISHING	POWER SUPPLY	LUMEN OUTPUT	CONSUMPTION	CURRENT		PACKAGING
DOI-S2L24	Grey	24 Vcc	1800 lm	23 W	0,958 A	4,4	1

Accessories

Remote controls



S-TE Remote control for up to 300 fittings standard or autotest

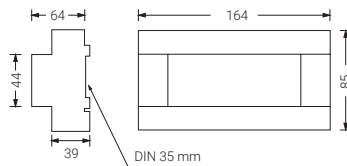

Antivandalic enclosure

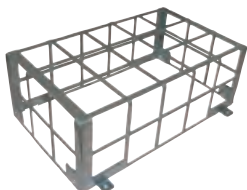

DO-AV Antivandalic enclosure.
Measurements in cm: 45 x 30 x 25

PACKAGING

1





Twin spots

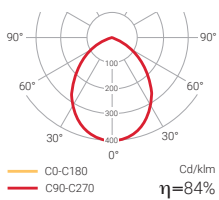

The TWIN SPOTS have been designed to illuminate large working areas. Their IP65 rating and their wide luminic range, combined with the tightness of their housing, make them the ideal solution to light up large industrial areas.

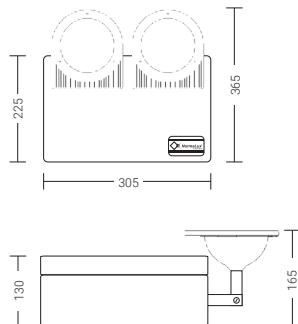

Lm
1000-5980

1-2-3



Pb

IP
65

IK
07

230 Vac

EN 60598-2-22

Remote controlled

Twin spots

Standard

Non-maintained LED

IP
65

	FINISHING	COM.	LUMEN OUTPUT	AUTONOMY		PACKAGING
FO-1100L	Grey	–	1040 lm	1 h	6,3	1
FO-1900L	Grey	–	1850 lm	1 h	6,9	1
FO-2400L	Grey	–	2300 lm	1 h	7,3	1
FO-3000L	Grey	–	3500 lm	1 h	8,2	1
FO-6000L	Grey	–	5980 lm	1 h	13,4	1
FO2-1900L	Grey	–	1850 lm	2 h	7,3	1
FO3-1000L	Grey	–	1000 lm	3 h	7,3	1



Accessories

Antivandalic enclosure

		PACKAGING
FO-AV	Antivandalic enclosure. Measurements in cm: 48 x 42 x19	1



Explosion proof



CATEGORY 2
ACCORDING TO
ATEX 2014/34/UE

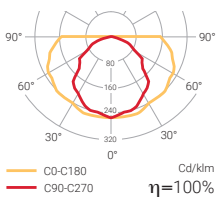

The EXPLOSION PROOF range has been specifically designed to be used in explosive atmospheres that have been designated category II in accordance with Directive ATEX 2014/34/UE.

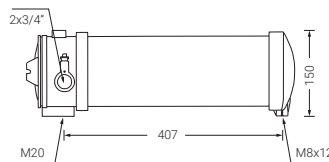
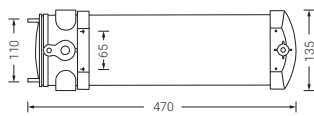

Lm
200-400

1



IP
67

IK
06



EN 60598-2-22
EN50018



Wall mounting plate
not included.
Anti explosion cable
glands not included.



Remote controlled.

Valid for sites designated category II in accordance with Directive ATEX 2014/34/UE.

Zone: 1, 21. Exd. IIC T6.

Explosion proof

Standard

Non-maintained / Fluorescent

IP
67

	FINISHING	COM.	LUMEN OUTPUT	AUTONOMY		PACKAGING
EX-200	Glass	–	200 lm	1 h	5,1	1
EX-400	Glass	–	400 lm	1 h	5,5	1

Autotest

Non-maintained / Fluorescent

IP
67

	FINISHING	COM.	LUMEN OUTPUT	AUTONOMY		PACKAGING
EXA-200	Glass	–	200 lm	1 h	5,3	1
EXA-400	Glass	–	400 lm	1 h	5,4	1

Intelligent DALI

Compatible with **NormaLINK** 



Non-maintained / Fluorescent

IP
67

	FINISHING	COM.	LUMEN OUTPUT	AUTONOMY		PACKAGING
EXID-200	Glass	DALI	200 lm	1 h	5,0	1
EXID-400	Glass	DALI	400 lm	1 h	5,4	1

Accessories

Remote controls



S-TE Remote control for up to 300 fittings standard or autotest

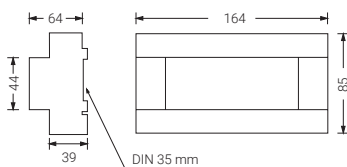

Wall mounting

BRIDAEX Wall mounting accessory



Exit signs

Lissa Exit Signs	122
Extraline	126
Steeled	130
Signal 7	132



New



Perpendicular or parallel mounting accessories are included in the surface mounted versions.

Lissa

exit signs



VIEWING DISTANCE

48 m.

with pictograms
Type PLI-A/SD/SU

10 m.

with pictograms
Type PLI-BIE/EXT/PUL

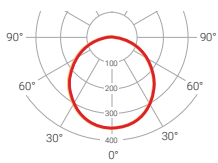

— CD-C180 Cd/km
— C90-C270 $\eta=100\%$

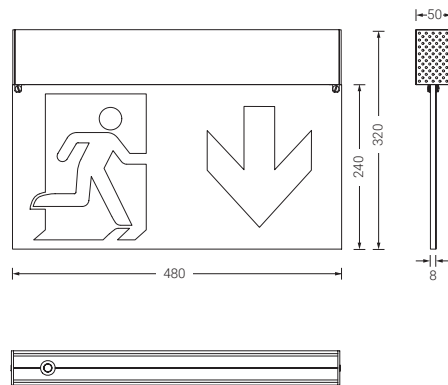

Blade diffuser and pictograms PLI-A, PLI-SU and PLI-SD included



Available also as emergency light (page 74)



For special luminaires, please contact us



EN 60598-2-22
EN 60598-1

EN 1838 | 48 m

Lissa exit signs surface mounted

Surface

Standard

Maintained MULTILED

IP
20

	FINISHING	COM	AUTONOMY		PACKAGING
LN	White	—	1 h	3,3	20
LN3	White	—	3 h	3,7	20

Autotest

Maintained MULTILED

IP
20

	FINISHING	COM	AUTONOMY		PACKAGING
LNA	White	—	1 h	3,3	20
LNA3	White	—	3 h	3,7	20

Intelligent DALI

Compatible with **NormaLINK** 

Maintained MULTILED

IP
20

	FINISHING	COM	AUTONOMY		PACKAGING
LNID	White	DALI	1 h	3,3	20
LNID3	White	DALI	3 h	2,8	20

Central Battery System

Maintained MULTILED

IP
20

	FINISHING	POWER SUPPLY	LUMEN OUTPUT	CONSUMPTION	CURRENT		PACKAGING
C24 LN-S16L24	White	24 Vcc	—	4 W	0,166 A	2,6	20
C24i LNI-S16L24	White	24 Vcc	—	4 W	0,166 A	3,0	20
LN-S16L	White	230 Vca	—	5 W	0,044 A	3,0	20

Accessories

Suspension accessory

LN-KS Suspended from the ceiling by a steel cable (including power supply wire of 2 m)

Pictograms

Type PLI Non adhesive pictogram 480 x 240 mm. *References according to table below***Type PLI** 480 x 240 mmREF. **PLI-A**REF. **PLI-A**REF. **PLI-SD**REF. **PLI-SU**Maximum viewing distance
(according to EN1838 for
internally illuminated signs)**48 m**REF. **PLI-BIE**REF. **PLI-EXT**REF. **PLI-PUL**Maximum viewing distance
(according to CTE)**10 m**Please check for other
pictograms

Recessed mounting

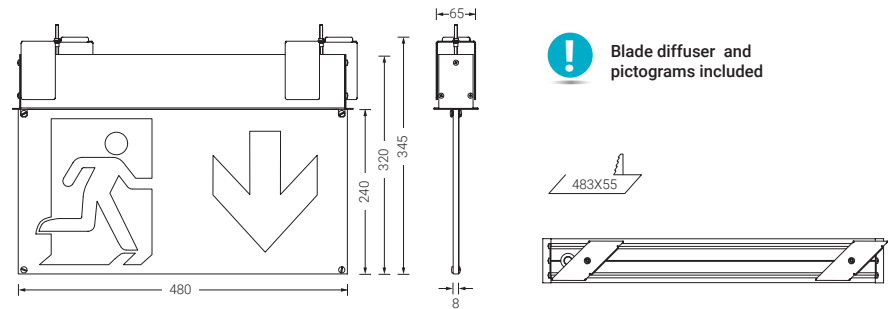

Standard

Maintained MULTILED

IP 20

	FINISHING	COM	AUTONOMY		PACKAGING
LNE	White	—	1 h	3,9	20
LNE3	White	—	3 h	4,3	20

Autotest

Maintained MULTILED

IP 20

	FINISHING	COM	AUTONOMY		PACKAGING
LNEA	White	—	1 h	3,9	20
LNEA3	White	—	3 h	4,3	20



Lissa exit signs recessed mounting

Intelligent DALI

Compatible with **NormaLINK**



Maintained MULTILED

IP 20

	FINISHING	COM	AUTONOMY		PACKAGING
LNEID	White	DALI	1 h	3,9	20
LNEID3	White	DALI	3 h	3,3	20

Each fitting includes:

- A LN fitting
- A blade diffuser
- Four pictograms (2 PLI-A, 1 PLI-SU and 1 PLI-W)

Central Battery System

Maintained MULTILED

IP 20

	FINISHING	POWER SUPPLY	LUMEN OUTPUT	CONSUMPTION	CURRENT		PACKAGING
C24	LNE-S16L24	White	24 Vcc	—	4 W	0,166 A	3,1 20
C24i	LNEI-S16L24	White	24 Vcc	—	4 W	0,166 A	3,6 20
	LNE-S16L	White	230 Vca	—	5 W	0,044 A	4,1 20

Accessories

Pictograms

Type PLI Non adhesive pictogram 480 x 240 mm. *References according to table below*

Type PLI 480 x 240 mm

REF: **PLI-A**



REF: **PLI-A**



REF: **PLI-SD**



REF: **PLI-SU**



Maximum viewing distance (according to EN1838 for internally illuminated signs)

48 m

REF: **PLI-BIE**



REF: **PLI-EXT**



REF: **PLI-PUL**



Maximum viewing distance (according to CTE)

10 m



Please check for other pictograms



Extraline



VIEWING DISTANCE

30 m.

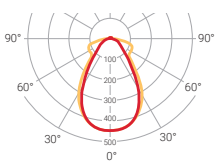

— C0-C180
— C90-C270
Cd/klm
η=77%

EXTRALINE has been born as an evolved version of the SIGNAL7 product range with two models depending on the mode of operation:

- Exit sign model (reference XS), to help locate the exits in the evacuation route.
- Exit sign + emergency lighting model (reference XD), Which locates the exits and illuminates the evacuation route at the same time. This second function is achieved by means of a secondary source of light located in the lower part of the pictogram.

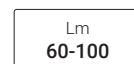
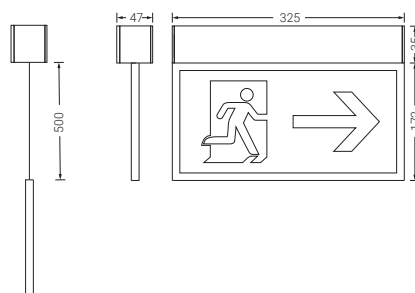

EN 60598-2-22

EN 60598-1

EN 1838 | 30 m



Blade diffuser, suspension kit and pictograms PEX-A, PEX-SU and PEX-W included.

Extraline

Standard

Maintained / Non-maintained MULTILED

IP 20

	FINISHING	COM.	LUMEN OUTPUT	AUTONOMY		PACKAGING
XS	White	–	–	1 h	1,1	12
XD	White	–	100 lm	1 h	1,2	12
XS3	White	–	–	3 h	1,1	12
XD3	White	–	60 lm	3 h	1,2	12

XD Fitting with double function:

Exit sign and emergency lighting

XS

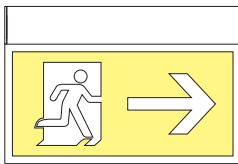

XD

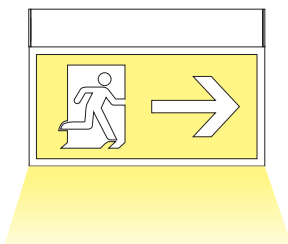

Two different mounting options not requiring extra accessories:
surface mounted on the ceiling or suspended from the ceiling.

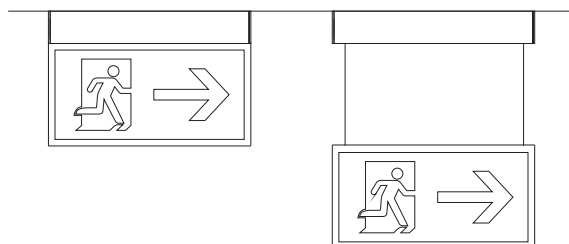

Extraline

Autotest

Maintained / Non-maintained MULTILED

IP
20

	FINISHING	COM.	LUMEN OUTPUT	AUTONOMY		PACKAGING
XSA	White	–	–	1 h	1,1	12
XDA	White	–	100 lm	1 h	1,2	12
XSA3	White	–	–	3 h	1,2	12
XDA3	White	–	60 lm	3 h	1,2	12

Intelligent DALI

Compatible with **NormaLINK** 

Maintained / Non-maintained MULTILED

IP
20

	FINISHING	COM.	LUMEN OUTPUT	AUTONOMY		PACKAGING
XSID	White	DALI	–	1 h	1,6	12
XDID	White	DALI	100 lm	1 h	1,7	12
XSID3	White	DALI	–	3 h	1,6	12
XDID3	White	DALI	60 lm	3 h	1,7	12

Intelligent
Wireless

Maintained / Non-maintained MULTILED

IP
20

	FINISHING	COM.	LUMEN OUTPUT	AUTONOMY		PACKAGING
XSID-R	White	DALI	–	1 h	1,6	12
XDID-R	White	DALI	100 lm	1 h	1,6	12
XSID3-R	White	DALI	–	3 h	1,6	12
XDID3-R	White	DALI	60 lm	3 h	1,7	12

Central Battery
System

Maintained MULTILED

IP
20

	FINISHING	POWER SUPPLY	LUMEN OUTPUT	CONSUMPTION	CURRENT		PACKAGING
XS-S	White	230 Vca	–	2,3 W	0,017 A	0,4	12
XD-S	White	230 Vca	100 lm	2,8 W	0,017 A	1,1	12
C24 XD-S24	White	24 Vcc	100 lm	2,2 W	0,092 A	1,1	12
C24 XS-S24	White	24 Vcc	–	1 W	0,042 A	1,1	12
C24i XDI-S24	White	24 Vcc	100 lm	2,4 W	0,100 A	1,1	12
C24i XSI-S24	White	24 Vcc	–	2,4 W	0,100 A	1,1	12

Each fitting includes:

- An XS or XD fitting
- A suspension kit (2 meters).
- Four pictograms (2 PEX-A, 1 PEX-SU and 1 PEX-W).

Extraline Accessories

Brackets

- X-SBF** Accessory for paralel to the wall mounting
- X-SBL** Accessory for perpendicular to the wall mounting

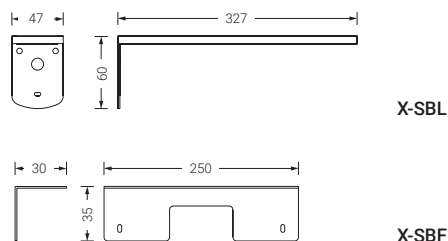

Recession frames

- X-ME** Metallic recession frame to install EXTRALINE series fittings into the ceiling (recessed)

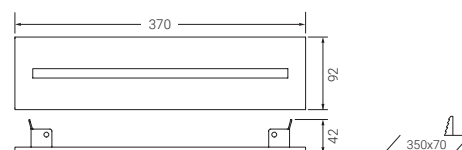

Remote controls

- S-TE** Remote control for up to 300 fittings standard or autotest

Pictograms

- Type PEX** Non adhesive pictogram 300x150 mm. *References according to table below*

Type PEX 300 x 150 mm



Maximum viewing distance
(according to EN1838 for
internally illuminated signs)

30 m

Pictograms included

Please check for other pictograms



Steeled



VIEWING
DISTANCE

24 m.

The STEELED Exit signs has been designed to offer a large visibility distance of 24 m while also offering an innovative and functional design. Constructed with stainless steel housing and a methacrylate blade which guarantees toughness and durability.

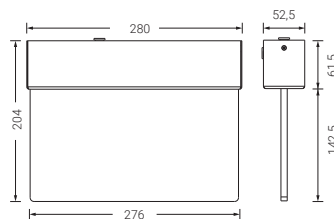

EN 60598-2-22
EN 60598-1

EN 1838 | 24 m



Remote controlled

Steeled

Standard

Maintained LED

IP
20

	FINISHING	COM.	AUTONOMY		PACKAGING
STT	Stainless steel	—	1 h	2,9	20
STP	Stainless steel	—	1 h	2,8	20
STT3	Stainless steel	—	3 h	3,1	20
STP3	Stainless steel	—	3 h	3,0	20

Autotest

Maintained LED

IP
20

	FINISHING	COM.	AUTONOMY		PACKAGING
STTA	Stainless steel	—	1 h	3,0	20
STPA	Stainless steel	—	1 h	2,8	20
STTA3	Stainless steel	—	3 h	3,1	20
STPA3	Stainless steel	—	3 h	3,0	20

Intelligent DALI

Compatible with **NormaLINK** 

Maintained LED

IP
20

	FINISHING	COM.	AUTONOMY		PACKAGING
STTID	Stainless steel	DALI	1 h	3,0	20
STPID	Stainless steel	DALI	1 h	2,8	20
STTID3	Stainless steel	DALI	3 h	3,1	20
STPID3	Stainless steel	DALI	3 h	3,0	20

Accessories

Remote controls

S-TE Remote control for up to 300 fittings standard or autotest

Pictograms

Type PST Pictogram 245x120 mm. *References according to table below.*



Please check for other pictograms

Type PST 245 x 120 mm

REF. PST-A



REF. PST-A



REF. PST-SD



REF. PST-SU



Maximum viewing distance
(according to EN1838 for
internally illuminated signs)

24 m



Parallel to the wall



Perpendicular to the wall



Signal 7



VIEWING DISTANCE

24 m.

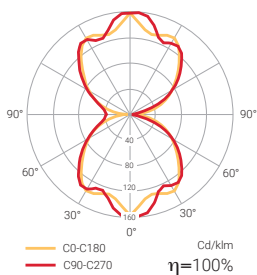

The SIGNAL 7 Exit Signs have been designed as extremely versatile fittings to cover all installation needs. Made with a polycarbonate housing and a methacrylate blade guaranteeing a visibility distance of 24 m.

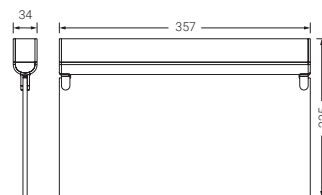

! Remote control option, please contact us



EN 60598-2-22
EN 60598-1

EN 1838 | 24 m

Signal 7

Standard

Maintained LED

IP
20

	FINISHING	COM.	AUTONOMY		PACKAGING
SG-K	White	—	1 h	0,9	8
SG-K-1	Anthracite	—	1 h	0,9	8
SG-K-2	Aluminium	—	1 h	0,9	8
SG3-K	White	—	3 h	0,9	8
SG3-K-1	Anthracite	—	3 h	0,9	8
SG3-K-2	Aluminium	—	3 h	0,9	8

Autotest

Maintained LED

IP
20

	FINISHING	COM.	AUTONOMY		PACKAGING
SGA-K	White	—	1 h	0,9	8
SGA-K-1	Anthracite	—	1 h	0,9	8
SGA-K-2	Aluminium	—	1 h	0,9	8
SGA3-K	White	—	3 h	0,9	8
SGA3-K-1	Anthracite	—	3 h	0,9	8
SGA3-K-2	Aluminium	—	3 h	0,9	8

Non-maintained LED

IP
20

	FINISHING	COM.	AUTONOMY		PACKAGING
SGEA-K	White	—	1 h	0,9	8
SGEA-K-1	Anthracite	—	1 h	0,9	8
SGEA-K-2	Aluminium	—	1 h	0,9	8
SGEA3-K	White	—	3 h	0,9	8
SGEA3-K-1	Anthracite	—	3 h	0,9	8
SGEA3-K-2	Aluminium	—	3 h	0,9	8



Each fitting includes:

- An SG fitting
- A diffuser blade SG-DB
- Four pictograms (2 left / 1 down / 1 white)
- An SG-AT accessory containing 3 pieces to install the SIGNAL fitting to the wall, either parallel or perpendicular.

Signal 7

Intelligent DALI

Compatible with **NormaLINK** 

Maintained LED

	FINISHING	COM.	AUTONOMY		PACKAGING
SGID-K	White	DALI	1 h	0,9	8
SGID-K-1	Anthracite	DALI	1 h	0,9	8
SGID-K-2	Aluminium	DALI	1 h	0,9	8
SGID3-K	White	DALI	3 h	0,9	8
SGID3-K-1	Anthracite	DALI	3 h	0,9	8
SGID3-K-2	Aluminium	DALI	3 h	0,9	8

Non-maintained LED

	FINISHING	COM.	AUTONOMY		PACKAGING
SGEID3-K	White	DALI	3 h	0,9	8
SGEID3-K-1	Anthracite	DALI	3 h	0,9	8
SGEID3-K-2	Aluminium	DALI	3 h	0,9	8

Central Battery System

Maintained LED

	FINISHING	POWER SUPPLY	CONSUMPTION	CURRENT		PACKAGING	
C24	SG-S24-K	White	24 Vcc	1,7 W	0,071 A	0,8	8
C24	SG-S24-K-1	Anthracite	24 Vcc	1,7 W	0,071 A	0,8	8
C24	SG-S24-K-2	Aluminium	24 Vcc	1,7 W	0,071 A	0,8	8
C24i	SIG-S24-K	White	24 Vcc	2,4 W	0,100 A	0,8	8
C24i	SIG-S24-K-1	Anthracite	24 Vcc	2,4 W	0,100 A	0,8	8
C24i	SIG-S24-K-2	Aluminium	24 Vcc	2,4 W	0,100 A	0,8	8

Each fitting includes:

- An SG fitting
- A diffuser blade SG-DB
- Four pictograms (2 left / 1 down / 1 white)
- An SG-AT accessory containing 3 pieces to install the SIGNAL fitting to the wall, either parallel or perpendicular.

Signal 7

Electrified track



Standard

Maintained LED

IP 20

	FINISHING	COM.	LUMEN OUTPUT	AUTONOMY		PACKAGING
SG-KD	White	—	100 lm	1 h	0,8	8
SG-KD-1	Anthracite	—	100 lm	1 h	0,8	8
SG-KD-2	Aluminium	—	100 lm	1 h	0,8	8

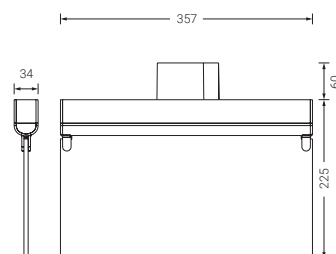

Each fitting includes:

- An SG fitting
- A diffuser blade SG-DB
- Four pictograms (2 left / 1 down / 1 white)

Signal 7 Accessories

Assembly accessories

SG-AT Fixation to the wall

Parallel to the wall
SG + SG-DB + SG-AT

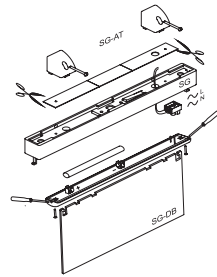

Perpendicular to the wall
SG + SG-DB + SG-AT

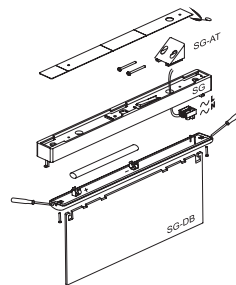

SG-AC Set of accessories for assembly in a recessed universal box. White

SG-AC-1 Set of accessories for assembly in a recessed universal box. Anthracite

SG-AC-2 Set of accessories for assembly in a recessed universal box. Aluminium

Parallel to the wall

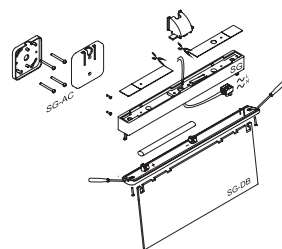

Perpendicular to the wall

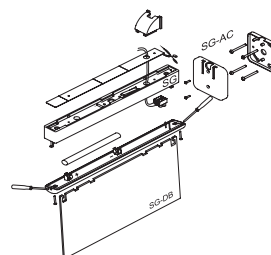

Fixation to the wall

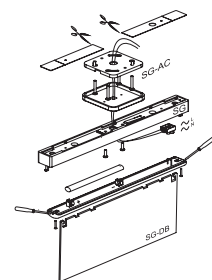

Signal 7 Accessories

Recession frames



- SG-ME** Recession frame. White colour
- SG-ME-1** Recession frame. Anthracite colour
- SG-ME-2** Recession frame. Aluminium colour

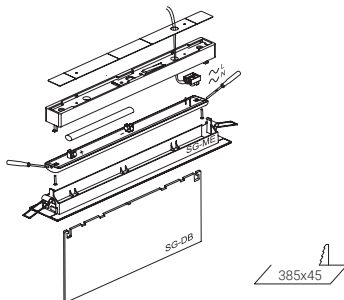

Ceiling mounting accessories



- SGKS-C** Ceiling suspension accessorie 100mm long. White colour
- SGKS-C-1** Ceiling suspension accessorie 100mm long. Anthracite colour
- SGKS-C-2** Ceiling suspension accessorie 100mm long. Aluminium colour
- SGKS-30** Ceiling suspension accessorie 300mm long. White colour
- SGKS-30-1** Ceiling suspension accessorie 300mm long. Anthracite colour
- SGKS-30-2** Ceiling suspension accessorie 300mm long. Aluminium colour
- SGKS-100** Ceiling suspension accessorie 1000mm long. White colour
- SGKS-100-1** Ceiling suspension accessorie 1000mm long. Anthracite colour
- SGKS-100-2** Ceiling suspension accessorie 1000mm long. Aluminium colour

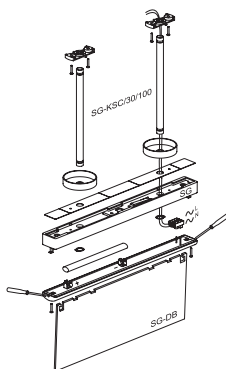

Pictograms

Type SG Non adhesive pictogram 300 x 120 mm. *References according to table below*

! Please check for other pictograms

REF. SG-NL	REF. SG-NR	REF. SG-NSD	REF. SG-NSU

Maximum viewing distance
(according to EN1838 for internally illuminated signs)

24 m



Step lighting

Power supply module MA24-6	140
Passo	142
Sirio	144
Estela	146
Senda	150
MIB Step light	154
BR Step light	155

Power supply module for step lights

Power supply module for 24v step lights
DIN Rail mounted.





New



MA24-6

Power supply module for step lights

Technical features:

- Power supply: 230V AC – 50/60 Hz
- Output: 24v DC
- Power: 6w
- Maintained / Non maintained functioning through the control input.
- Battery included (7,2v – 1300mA NiMh)
- Duration: 1 hour
- DIN Rail mounted: 10 modules
- Dimensions: 164 x 84 x 64mm
- IP20 IK04
- LEDs indicating functioning, status and battery charge
- LEDs indicating failure and 24v DC output status.
- **Powers up to 17 step lights from the Passo, Sirio, Estela or Senda step lights (24Vcc versions).**

Step lights compatible with MA24-6

Passo
Sirio
Estela recessed
Estela surface
Senda recessed
Senda surface
MIB
BR / BRE
BRU / BREU

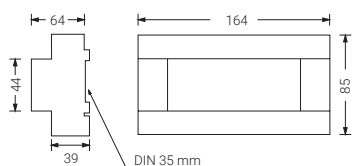

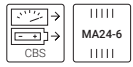

Recessed
exit step light

IP65

Centralized
power supply
24 Vcc



Passo

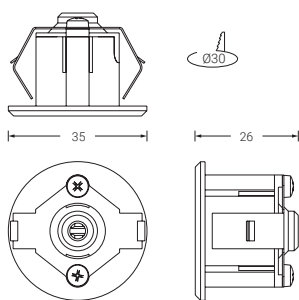

It requires the C24 central battery systems to comply with the low voltage directives as step lighting (information on page 158)

No accessories needed for installation.

IP
65

	LAMP	COLOUR LED	POWER SUPPLY	CONSUMPTION	PACKAGING
BP24	LED	White	24 Vcc	0,35 W	20
BP24A	LED	Blue	24 Vcc	0,35 W	20
BP24R	LED	Red	24 Vcc	0,35 W	20
BP24V	LED	Green	24 Vcc	0,35 W	20

For other finishings, please consult check.

Compatible with the C24 central battery system (information on page 158) and with the power supply module for step lights MA24-6 (information on page 140).

INDICATIVE CHART OF STEP LIGHTS NUMBER

	Central		Module
	C24-100M	C24-300M	MA24-6
Ref. BP24	200 fittings	600 fittings	17 step lights

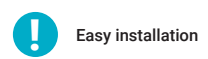

Passo

Accessories

Power supply module

MA24-6 Power supply module for 24v step lights DIN Rail mounted.
Up to 17 Passo step lights with a MA24-6 central

Central Battery System

C24-100M Central Battery System 100 W

C24-300M Central Battery System 300 W

C24I-300 Central Battery System 300 W addressable



Central Battery Systems are provided without batteries
For more information, please check page 158.

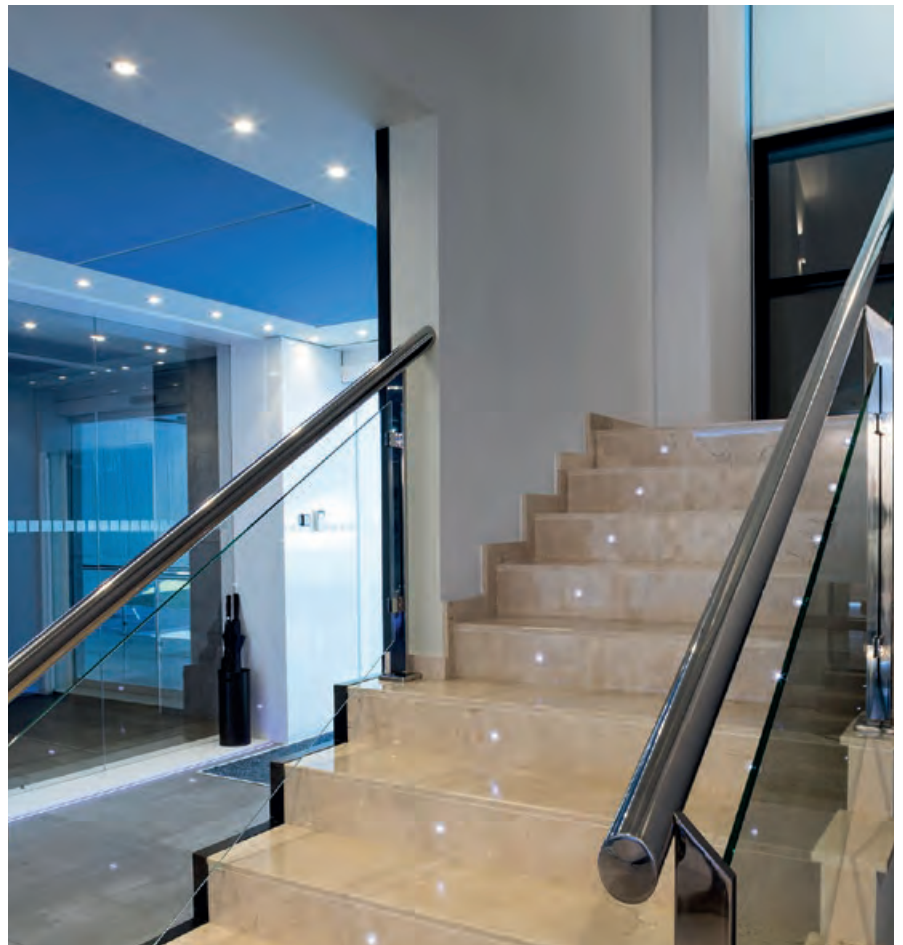



Recessed step light

24V CBS version available

Sirio

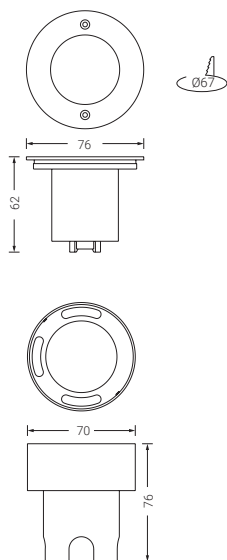

Technical features:

- Recessed mounted (recession frame included).
- Reference regulations EN 60598-1
- Power 230V, 50/60 Hz.
- Exterior ring made of ZAMAK with aluminium finishing.
- Housing and diffuser: Polycarbonate
- IP-65. IK-07
- Class II.
- Can be mounted on a flammable surface.
- Charging time 24 hours.
- Possibility of remote control.
- Different light colours.

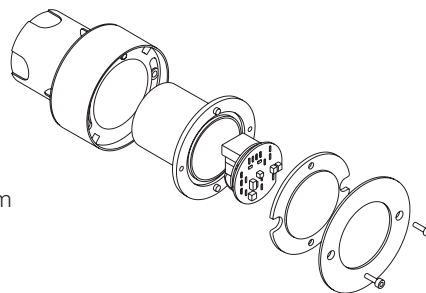

IP 65

	LAMP	COLOUR LED	AUTONOMY	BATTERY	COS (φ)	CONSUMPTION	PACKAGING
BS	LED	White	2 h	3,6 V · 80 mAh	0,07	0,28 W	20
BSA	LED	Blue	2 h	3,6 V · 80 mAh	0,07	0,28 W	20
BSR	LED	Red	2 h	3,6 V · 80 mAh	0,07	0,28 W	20
BSV	LED	Green	2 h	3,6 V · 80 mAh	0,07	0,28 W	20

Available 24v DC, ref: + Y

24v DC version is compatible with the C24 central battery system (information on page 158) and with the power supply module for step lights MA24-6 (information on page 140).





Step light for universal box

24V CBS version available



Estela recessed mounted

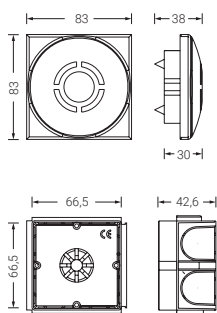

REF: ET

REF: ER

REF: EC

Finishing:

Grey: RAL7047

Anthracite: RAL7015

Aluminium: RAL7004

Technical features::

- Universal box installation.
- Reference regulations EN 60598-1
- Power 230V, 50/60 Hz.
- Versions for 127V 50/60Hz and 24V DC.
- Housing and diffuser: Polycarbonate
- Class II. IP-44. IK-07
- Can be mounted on a flammable surface.
- Charging time 24 hours.
- Possibility of remote control.
- Different light colours.

24v DC version is compatible with the C24 central battery system (information on page 158) and with the power supply module for step lights MA24-6 (information on page 140).

Estela recessed mounted

IP
44

	FINISHING	LAMP	COLOUR LED	AUTONOMY	BATTERY	COS (φ)	CONSUMPTION	PACKAGING
EC-E	Grey	LED	White	1 h	3,6 V · 60 mAh	0,07	0,35 W	20
EC-E-1	Anthracite	LED	White	1 h	3,6 V · 60 mAh	0,07	0,35 W	20
EC-E-2	Aluminium	LED	White	1 h	3,6 V · 60 mAh	0,07	0,35 W	20
ER-E	Grey	LED	White	1 h	3,6 V · 60 mAh	0,07	0,35 W	20
ER-E-1	Anthracite	LED	White	1 h	3,6 V · 60 mAh	0,07	0,35 W	20
ER-E-2	Aluminium	LED	White	1 h	3,6 V · 60 mAh	0,07	0,35 W	20
ET-E	Grey	LED	White	1 h	3,6 V · 60 mAh	0,07	0,35 W	20
ET-E-1	Anthracite	LED	White	1 h	3,6 V · 60 mAh	0,07	0,35 W	20
ET-E-2	Aluminium	LED	White	1 h	3,6 V · 60 mAh	0,07	0,35 W	20
ECA-E	Grey	LED	Blue	1 h	3,6 V · 60 mAh	0,07	0,35 W	20
ECA-E-1	Anthracite	LED	Blue	1 h	3,6 V · 60 mAh	0,07	0,35 W	20
ECA-E-2	Aluminium	LED	Blue	1 h	3,6 V · 60 mAh	0,07	0,35 W	20
ERA-E	Grey	LED	Blue	1 h	3,6 V · 60 mAh	0,07	0,35 W	20
ERA-E-1	Anthracite	LED	Blue	1 h	3,6 V · 60 mAh	0,07	0,35 W	20
ERA-E-2	Aluminium	LED	Blue	1 h	3,6 V · 60 mAh	0,07	0,35 W	20
ETA-E	Grey	LED	Blue	1 h	3,6 V · 60 mAh	0,07	0,35 W	20
ETA-E-1	Anthracite	LED	Blue	1 h	3,6 V · 60 mAh	0,07	0,35 W	20
ETA-E-2	Aluminium	LED	Blue	1 h	3,6 V · 60 mAh	0,07	0,35 W	20
ECR-E	Grey	LED	Red	1 h	3,6 V · 60 mAh	0,07	0,35 W	20
ECR-E-1	Anthracite	LED	Red	1 h	3,6 V · 60 mAh	0,07	0,35 W	20
ECR-E-2	Aluminium	LED	Red	1 h	3,6 V · 60 mAh	0,07	0,35 W	20
ERR-E	Grey	LED	Red	1 h	3,6 V · 60 mAh	0,07	0,35 W	20
ERR-E-1	Anthracite	LED	Red	1 h	3,6 V · 60 mAh	0,07	0,35 W	20
ERR-E-2	Aluminium	LED	Red	1 h	3,6 V · 60 mAh	0,07	0,35 W	20
ETR-E	Grey	LED	Red	1 h	3,6 V · 60 mAh	0,07	0,35 W	20
ETR-E-1	Anthracite	LED	Red	1 h	3,6 V · 60 mAh	0,07	0,35 W	20
ETR-E-2	Aluminium	LED	Red	1 h	3,6 V · 60 mAh	0,07	0,35 W	20
ECV-E	Grey	LED	Green	1 h	3,6 V · 60 mAh	0,07	0,35 W	20
ECV-E-1	Anthracite	LED	Green	1 h	3,6 V · 60 mAh	0,07	0,35 W	20
ECV-E-2	Aluminium	LED	Green	1 h	3,6 V · 60 mAh	0,07	0,35 W	20
ERV-E	Grey	LED	Green	1 h	3,6 V · 60 mAh	0,07	0,35 W	20
ERV-E-1	Anthracite	LED	Green	1 h	3,6 V · 60 mAh	0,07	0,35 W	20
ERV-E-2	Aluminium	LED	Green	1 h	3,6 V · 60 mAh	0,07	0,35 W	20
ETV-E	Grey	LED	Green	1 h	3,6 V · 60 mAh	0,07	0,35 W	20
ETV-E-1	Anthracite	LED	Green	1 h	3,6 V · 60 mAh	0,07	0,35 W	20
ETV-E-2	Aluminium	LED	Green	1 h	3,6 V · 60 mAh	0,07	0,35 W	20

Available **24v DC**, ref: + Y

Accessories

Remote controls

S-TE

Remote control for up to 300 fittings standard or autotest



Surface mounted step light

24V CBS version available



Estela surface mounted

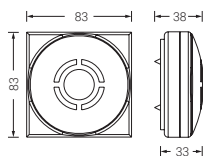

REF: ET

REF: ER

REF: EC

Finishing:

Grey: RAL7047

Anthracite: RAL7015

Aluminium: RAL7004

Technical features:

- Surface mounted.
- Reference regulations EN 60598-1
- Power 230V, 50/60 Hz.
- Versions for 127V 50/60Hz and 24V DC.
- Housing and diffuser: Polycarbonate
- Class II. IP-44. IK-07
- Can be mounted on a flammable surface.
- Charging time 24 hours.
- Possibility of remote control.
- Different light colours.

24v DC version is compatible with the C24 central battery system (information on page 158) and with the power supply module for step lights MA24-6 (information on page 140).

Estela surface mounted

IP
44

	FINISHING	LAMP	COLOUR LED	AUTONOMY	BATTERY	COS (φ)	CONSUMPTION	PACKAGING
EC-S	Grey	LED	White	1 h	3,6 V · 60 mAh	0,07	0,35 W	20
EC-S-1	Anthracite	LED	White	1 h	3,6 V · 60 mAh	0,07	0,35 W	20
EC-S-2	Aluminium	LED	White	1 h	3,6 V · 60 mAh	0,07	0,35 W	20
ER-S	Grey	LED	White	1 h	3,6 V · 60 mAh	0,07	0,35 W	20
ER-S-1	Anthracite	LED	White	1 h	3,6 V · 60 mAh	0,07	0,35 W	20
ER-S-2	Aluminium	LED	White	1 h	3,6 V · 60 mAh	0,07	0,35 W	20
ET-S	Grey	LED	White	1 h	3,6 V · 60 mAh	0,07	0,35 W	20
ET-S-1	Anthracite	LED	White	1 h	3,6 V · 60 mAh	0,07	0,35 W	20
ET-S-2	Aluminium	LED	White	1 h	3,6 V · 60 mAh	0,07	0,35 W	20
ECA-S	Grey	LED	Blue	1 h	3,6 V · 60 mAh	0,07	0,35 W	20
ECA-S-1	Anthracite	LED	Blue	1 h	3,6 V · 60 mAh	0,07	0,35 W	20
ECA-S-2	Aluminium	LED	Blue	1 h	3,6 V · 60 mAh	0,07	0,35 W	20
ERA-S	Grey	LED	Blue	1 h	3,6 V · 60 mAh	0,07	0,35 W	20
ERA-S-1	Anthracite	LED	Blue	1 h	3,6 V · 60 mAh	0,07	0,35 W	20
ERA-S-2	Aluminium	LED	Blue	1 h	3,6 V · 60 mAh	0,07	0,35 W	20
ETA-S	Grey	LED	Blue	1 h	3,6 V · 60 mAh	0,07	0,35 W	20
ETA-S-1	Anthracite	LED	Blue	1 h	3,6 V · 60 mAh	0,07	0,35 W	20
ETA-S-2	Aluminium	LED	Blue	1 h	3,6 V · 60 mAh	0,07	0,35 W	20
ECR-S	Grey	LED	Red	1 h	3,6 V · 60 mAh	0,07	0,35 W	20
ECR-S-1	Anthracite	LED	Red	1 h	3,6 V · 60 mAh	0,07	0,35 W	20
ECR-S-2	Aluminium	LED	Red	1 h	3,6 V · 60 mAh	0,07	0,35 W	20
ERR-S	Grey	LED	Red	1 h	3,6 V · 60 mAh	0,07	0,35 W	20
ERR-S-1	Anthracite	LED	Red	1 h	3,6 V · 60 mAh	0,07	0,35 W	20
ERR-S-2	Aluminium	LED	Red	1 h	3,6 V · 60 mAh	0,07	0,35 W	20
ETR-S	Grey	LED	Red	1 h	3,6 V · 60 mAh	0,07	0,35 W	20
ETR-S-1	Anthracite	LED	Red	1 h	3,6 V · 60 mAh	0,07	0,35 W	20
ETR-S-2	Aluminium	LED	Red	1 h	3,6 V · 60 mAh	0,07	0,35 W	20
ECV-S	Grey	LED	Green	1 h	3,6 V · 60 mAh	0,07	0,35 W	20
ECV-S-1	Anthracite	LED	Green	1 h	3,6 V · 60 mAh	0,07	0,35 W	20
ECV-S-2	Aluminium	LED	Green	1 h	3,6 V · 60 mAh	0,07	0,35 W	20
ERV-S	Grey	LED	Green	1 h	3,6 V · 60 mAh	0,07	0,35 W	20
ERV-S-1	Anthracite	LED	Green	1 h	3,6 V · 60 mAh	0,07	0,35 W	20
ERV-S-2	Aluminium	LED	Green	1 h	3,6 V · 60 mAh	0,07	0,35 W	20
ETV-S	Grey	LED	Green	1 h	3,6 V · 60 mAh	0,07	0,35 W	20
ETV-S-1	Anthracite	LED	Green	1 h	3,6 V · 60 mAh	0,07	0,35 W	20
ETV-S-2	Aluminium	LED	Green	1 h	3,6 V · 60 mAh	0,07	0,35 W	20

Available 24v DC, ref: + Y

Accessories

Remote controls

S-TE

Remote control for up to 300 fittings standard or autotest



Step light for universal box

24V CBS
version available



Senda recessed mounted

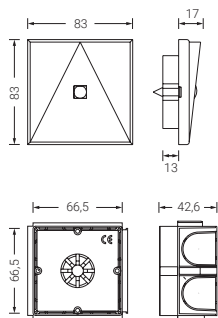

REF: NT

REF: NR

REF: NC

Finishing:

Grey: RAL7047
Anthracite: RAL7015
Aluminium: RAL7004

Technical features:

- Universal box installation.
- Reference norms EN 60598-1
- Power 230V, 50/60 Hz.
- Versions for 127V 50/60Hz and 24V DC.
- Housing and diffuser: Polycarbonate
- Class II. IP-44. IK-07
- Can be mounted on a flammable surface.
- Charging time 24 hours.
- Possibility of remote control.
- Different light colours.

24v DC version is compatible with the C24 central battery system (information on page 158) and with the power supply module for step lights MA24-6 (information on page 140).

Senda recessed mounted

IP
44

	FINISHING	LAMP	COLOUR LED	AUTONOMY	BATTERY	COS (φ)	CONSUMPTION	PACKAGING
NC-E	Grey	LED	White	1 h	3,6 V · 60 mAh	0,07	0,35 W	20
NC-E-1	Anthracite	LED	White	1 h	3,6 V · 60 mAh	0,07	0,35 W	20
NC-E-2	Aluminium	LED	White	1 h	3,6 V · 60 mAh	0,07	0,35 W	20
NR-E	Grey	LED	White	1 h	3,6 V · 60 mAh	0,07	0,35 W	20
NR-E-1	Anthracite	LED	White	1 h	3,6 V · 60 mAh	0,07	0,35 W	20
NR-E-2	Aluminium	LED	White	1 h	3,6 V · 60 mAh	0,07	0,35 W	20
NTE	Grey	LED	White	1 h	3,6 V · 60 mAh	0,07	0,35 W	20
NTE-1	Anthracite	LED	White	1 h	3,6 V · 60 mAh	0,07	0,35 W	20
NTE-2	Aluminium	LED	White	1 h	3,6 V · 60 mAh	0,07	0,35 W	20
NCA-E	Grey	LED	Blue	1 h	3,6 V · 60 mAh	0,07	0,35 W	20
NCA-E-1	Anthracite	LED	Blue	1 h	3,6 V · 60 mAh	0,07	0,35 W	20
NCA-E-2	Aluminium	LED	Blue	1 h	3,6 V · 60 mAh	0,07	0,35 W	20
NRA-E	Grey	LED	Blue	1 h	3,6 V · 60 mAh	0,07	0,35 W	20
NRA-E-1	Anthracite	LED	Blue	1 h	3,6 V · 60 mAh	0,07	0,35 W	20
NRA-E-2	Aluminium	LED	Blue	1 h	3,6 V · 60 mAh	0,07	0,35 W	20
NTA-E	Grey	LED	Blue	1 h	3,6 V · 60 mAh	0,07	0,35 W	20
NTA-E-1	Anthracite	LED	Blue	1 h	3,6 V · 60 mAh	0,07	0,35 W	20
NTA-E-2	Aluminium	LED	Blue	1 h	3,6 V · 60 mAh	0,07	0,35 W	20
NCR-E	Grey	LED	Red	1 h	3,6 V · 60 mAh	0,07	0,35 W	20
NCR-E-1	Anthracite	LED	Red	1 h	3,6 V · 60 mAh	0,07	0,35 W	20
NCR-E-2	Aluminium	LED	Red	1 h	3,6 V · 60 mAh	0,07	0,35 W	20
NRR-E	Grey	LED	Red	1 h	3,6 V · 60 mAh	0,07	0,35 W	20
NRR-E-1	Anthracite	LED	Red	1 h	3,6 V · 60 mAh	0,07	0,35 W	20
NRR-E-2	Aluminium	LED	Red	1 h	3,6 V · 60 mAh	0,07	0,35 W	20
NTR-E	Grey	LED	Red	1 h	3,6 V · 60 mAh	0,07	0,35 W	20
NTR-E-1	Anthracite	LED	Red	1 h	3,6 V · 60 mAh	0,07	0,35 W	20
NTR-E-2	Aluminium	LED	Red	1 h	3,6 V · 60 mAh	0,07	0,35 W	20
NCV-E	Grey	LED	Green	1 h	3,6 V · 60 mAh	0,07	0,35 W	20
NCV-E-1	Anthracite	LED	Green	1 h	3,6 V · 60 mAh	0,07	0,35 W	20
NCV-E-2	Aluminium	LED	Green	1 h	3,6 V · 60 mAh	0,07	0,35 W	20
NRV-E	Grey	LED	Green	1 h	3,6 V · 60 mAh	0,07	0,35 W	20
NRV-E-1	Anthracite	LED	Green	1 h	3,6 V · 60 mAh	0,07	0,35 W	20
NRV-E-2	Aluminium	LED	Green	1 h	3,6 V · 60 mAh	0,07	0,35 W	20
NTV-E	Grey	LED	Green	1 h	3,6 V · 60 mAh	0,07	0,35 W	20
NTV-E-1	Anthracite	LED	Green	1 h	3,6 V · 60 mAh	0,07	0,35 W	20
NTV-E-2	Aluminium	LED	Green	1 h	3,6 V · 60 mAh	0,07	0,35 W	20

Available **24v DC**, ref: + Y

Accessories

Remote controls

S-TE

Remote control for up to 300 fittings standard or autotest



Surface mounted step light

24V CBS version available



Senda surface mounted

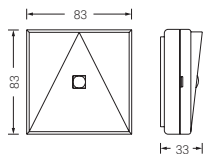

REF: NT

REF: NR

REF: NC

Finishing:

Grey: RAL7047

Anthracite: RAL7015

Aluminium: RAL7004

Technical features:

- Surface mounted.
- Reference regulations EN 60598-1
- Power 230V, 50/60 Hz.
- Versions for 127V 50/60Hz and 24V DC.
- Housing and diffuser: Polycarbonate.
- Class II. IP-44. IK-07
- Can be mounted on a flammable surface.
- Charging time 24 hours.
- Possibility of remote control.
- Different light colours.

24v DC version is compatible with the C24 central battery system (information on page 158) and with the power supply module for step lights MA24-6 (information on page 140).

Senda surface mounted

IP
44

	FINISHING	LAMP	COLOUR LED	AUTONOMY	BATTERY	COS (φ)	CONSUMPTION	PACKAGING
NC-S	Grey	LED	White	1 h	3,6 V · 60 mAh	0,07	0,35 W	20
NC-S-1	Anthracite	LED	White	1 h	3,6 V · 60 mAh	0,07	0,35 W	20
NC-S-2	Aluminium	LED	White	1 h	3,6 V · 60 mAh	0,07	0,35 W	20
NR-S	Grey	LED	White	1 h	3,6 V · 60 mAh	0,07	0,35 W	20
NR-S-1	Anthracite	LED	White	1 h	3,6 V · 60 mAh	0,07	0,35 W	20
NR-S-2	Aluminium	LED	White	1 h	3,6 V · 60 mAh	0,07	0,35 W	20
NT-S	Grey	LED	White	1 h	3,6 V · 60 mAh	0,07	0,35 W	20
NT-S-1	Anthracite	LED	White	1 h	3,6 V · 60 mAh	0,07	0,35 W	20
NT-S-2	Aluminium	LED	White	1 h	3,6 V · 60 mAh	0,07	0,35 W	20
NCA-S	Grey	LED	Blue	1 h	3,6 V · 60 mAh	0,07	0,35 W	20
NCA-S-1	Anthracite	LED	Blue	1 h	3,6 V · 60 mAh	0,07	0,35 W	20
NCA-S-2	Aluminium	LED	Blue	1 h	3,6 V · 60 mAh	0,07	0,35 W	20
NRA-S	Grey	LED	Blue	1 h	3,6 V · 60 mAh	0,07	0,35 W	20
NRA-S-1	Anthracite	LED	Blue	1 h	3,6 V · 60 mAh	0,07	0,35 W	20
NRA-S-2	Aluminium	LED	Blue	1 h	3,6 V · 60 mAh	0,07	0,35 W	20
NTA-S	Grey	LED	Blue	1 h	3,6 V · 60 mAh	0,07	0,35 W	20
NTA-S-1	Anthracite	LED	Blue	1 h	3,6 V · 60 mAh	0,07	0,35 W	20
NTA-S-2	Aluminium	LED	Blue	1 h	3,6 V · 60 mAh	0,07	0,35 W	20
NCR-S	Grey	LED	Red	1 h	3,6 V · 60 mAh	0,07	0,35 W	20
NCR-S-1	Anthracite	LED	Red	1 h	3,6 V · 60 mAh	0,07	0,35 W	20
NCR-S-2	Aluminium	LED	Red	1 h	3,6 V · 60 mAh	0,07	0,35 W	20
NRR-S	Grey	LED	Red	1 h	3,6 V · 60 mAh	0,07	0,35 W	20
NRR-S-1	Anthracite	LED	Red	1 h	3,6 V · 60 mAh	0,07	0,35 W	20
NRR-S-2	Aluminium	LED	Red	1 h	3,6 V · 60 mAh	0,07	0,35 W	20
NTR-S	Grey	LED	Red	1 h	3,6 V · 60 mAh	0,07	0,35 W	20
NTR-S-1	Anthracite	LED	Red	1 h	3,6 V · 60 mAh	0,07	0,35 W	20
NTR-S-2	Aluminium	LED	Red	1 h	3,6 V · 60 mAh	0,07	0,35 W	20
NCV-S	Grey	LED	Green	1 h	3,6 V · 60 mAh	0,07	0,35 W	20
NCV-S-1	Anthracite	LED	Green	1 h	3,6 V · 60 mAh	0,07	0,35 W	20
NCV-S-2	Aluminium	LED	Green	1 h	3,6 V · 60 mAh	0,07	0,35 W	20
NRV-S	Grey	LED	Green	1 h	3,6 V · 60 mAh	0,07	0,35 W	20
NRV-S-1	Anthracite	LED	Green	1 h	3,6 V · 60 mAh	0,07	0,35 W	20
NRV-S-2	Aluminium	LED	Green	1 h	3,6 V · 60 mAh	0,07	0,35 W	20
NTV-S	Grey	LED	Green	1 h	3,6 V · 60 mAh	0,07	0,35 W	20
NTV-S-1	Anthracite	LED	Green	1 h	3,6 V · 60 mAh	0,07	0,35 W	20
NTV-S-2	Aluminium	LED	Green	1 h	3,6 V · 60 mAh	0,07	0,35 W	20

Available 24v DC, ref: + Y

Accessories

Remote controls

S-TE

Remote control for up to 300 fittings standard or autotest



Step light

24V CBS
version available

MIB Step light

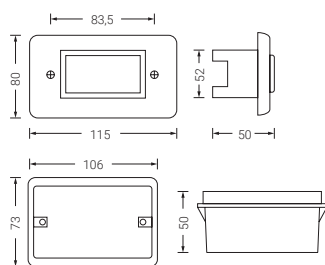

Technical features:

- White LED.
- Assembly: includes recession box.
- Reference norms EN 60598-1
- Signalling with a LED.
- Power 230V, 50/60 Hz.
- Housing and diffuser: Polycarbonate
- Charging time 24 hours.
- Possibility of remote control.

IP
42

24v DC version is compatible with the C24 central battery system (information on page 158) and with the power supply module for step lights MA24-6 (information on page 140).

	LAMP	COLOUR	IP	AUTONOMY	BATTERY	PACKAGING
MIB	LED	Glass	42	1 h	3,6 V · 60 mAh	20

LEDs available in different colors.
Available **24v DC**, ref: + Y



BR Step light

Step light

24V CBS
version available

BR/BRE

Technical features:

- White LED.
- Assembly: includes recession box.
- Reference norms EN 60598-1
- Signalling with a LED.
- Power 230V, 50/60 Hz.
- Housing and diffuser: Polycarbonate
- Charging time 24 hours.
- Possibility of remote control.
- IP 55 in Ref. BRE.

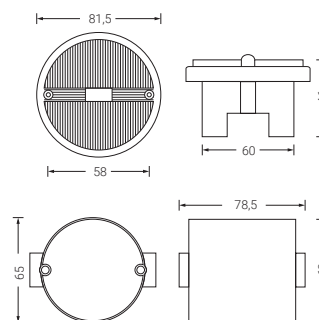

BRU/BREU

Technical features:

- White LED.
- Universal box installation (two screws).
- Reference norms EN 60598-1
- Signalling with a LED.
- Power 230V, 50/60 Hz.
- Housing and diffuser: Polycarbonate
- Charging time 24 hours.
- Possibility of remote control.
- IP 55 in Ref. BREU.
- White frame.

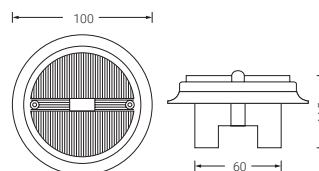
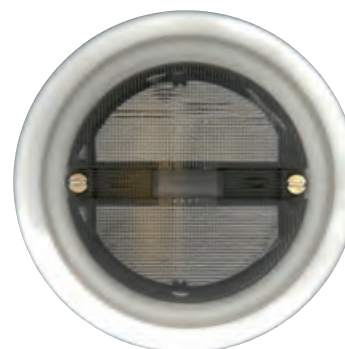

24v DC version is compatible with the C24 central battery system (information on page 158) and with the power supply module for step lights MA24-6 (information on page 140).

	LAMP	COLOUR	IP	AUTONOMY	BATTERY	PACKAGING
BR	LED	Grey	42	1 h	3,6 V · 60mAh	20
BRU	LED	Grey	42	1 h	3,6 V · 60mAh	20
BRE	LED	Grey	65	1 h	3,6 V · 60mAh	20
BREU	LED	Grey	65	1 h	3,6 V · 60mAh	20

LEDs available in different colors.
Available **24v DC**, ref: +Y



Central Battery System C24	158
Continuity lighting	162
Emergency lights for elevators	168
Light paths	169

Central Battery System

The family of C24 Central Battery Systems enables remote supply of 24 Vdc emergency luminaries.

C24

Manufactured in accordance with standard EN 50171



C24-100M

! Compatible with Modbus RTU



C24-300M

🔥 Covers one fire sector

! Compatible with Modbus RTU



C24I-300 | Sistema Addressable

🔥 Covers one fire sector

! Compatible with Normalink
Compatible with Modbus IP
Monitoring from the Normalink app and the Normalink BMS software



Autotest System

(functional test + autonomy test)

Compatible with MODBUS

As an innovation, Normalux launches a second generation of Central Battery Systems named C24i Addressable. These new centrals are able to control each fitting connected to them individually, and manage several options (turning on and off, dimming, test execution, etc), as well as monitoring the status of each luminaire.

While the basic version offers two references depending on the output power (C24-100 at 100 W and C24-300M at 300 W), in this new version there is just one reference of 300 W (C24i-300).

C24i addressable has 8 outputs, against C24 standard models that have only 4.

Intelligent control that helps to identify any possible problems and enables the control of:

- The Central unit itself and each of the 4 outputs of the standard version.
- The central unit itself, the outputs and each luminaire individually in the C24i-300 version.

All the fittings can be remotely controlled from a PC or a master Central (MODBUS).

C24i-300 fitting is compatible with Normalink. No external elements are needed.

Ranges compatible with 24 Vdc

- Via R
- Via S
- Via W
- Dunna
- Hermetic
- Extraplana
- Volutta
- Excellence
- Europisma
- ExtraLine
- Signal
- Estela
- Senda
- Sirio
- Passo
- MIB, BR, BRU
- Light paths

Control options

Through Normalink

C24i-300

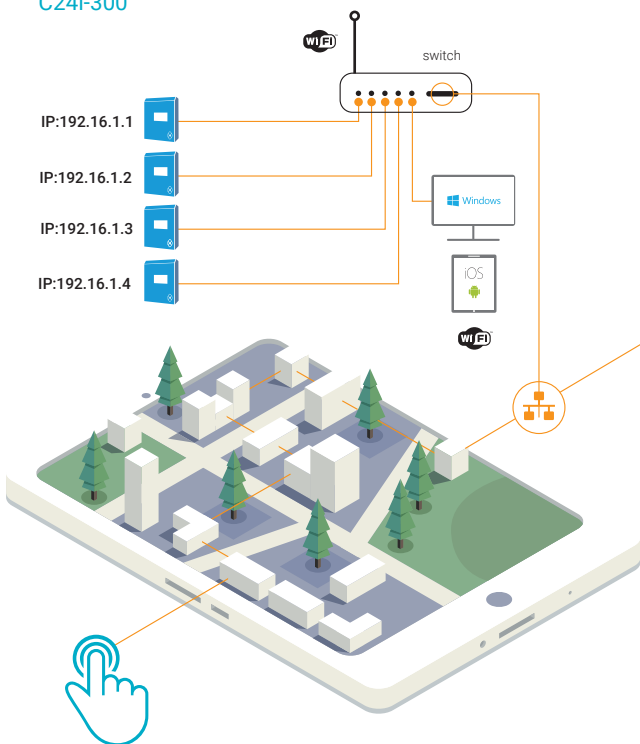

Through Modbus

C24-100
C24-300

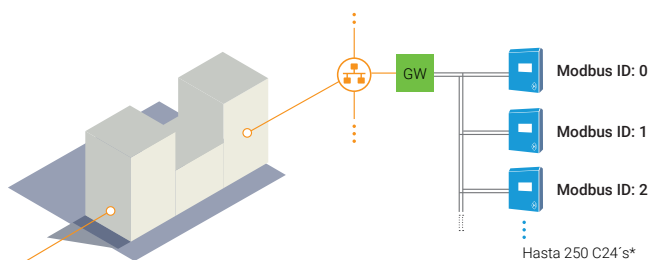

GW

Gateway (Modbus Rtu to...)

Shielded twisted pair
2 x 1,5 mm²
Maximum distance:
1.000 m.

* Depends on the limitations of the gateway.

HOME

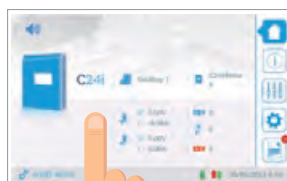

CONFIGURATION

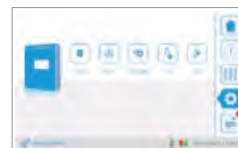

CONTROL



Central Battery System



Models	C24-100M						C24-300M								
	2 x 12 V · 7 Ah			2 x 12 V · 9 Ah			2 x 12 V · 12 Ah			2 x 12 V · 18 Ah			2 x 12 V · 24 Ah		
Batteries	1 h	3 h	8 h	1 h	3 h	8 h	1 h	3 h	8 h	1 h	3 h	8 h	1 h	3 h	8 h
Autonomy															
Total power output (W)	88 W	36 W	14 W	115 W	48 W	19 W	154 W	66 W	27 W	234 W	105 W	42 W	314 W	136 W	58 W
Maximum current (A)	3,86	1,70	0,76	4,97	2,19	0,97	6,62	2,92	1,30	9,94	4,39	1,95	13,25	5,85	2,60
Phase monitor input			✓									✓			
Output control				4						4					
Potential free contacts			✓									✓			
Function indicator			✓									✓			
Supply indicator for battery			✓									✓			
Failure			✓									✓			
Network supply indicator			✓									✓			
Battery supply indicator			✓									✓			
Failure alarm indicator			✓									✓			
Full discharge indicator			✓									✓			
Active output indicator			✓									✓			
Communication via bus			Modbus-RTU									Modbus-RTU			



New

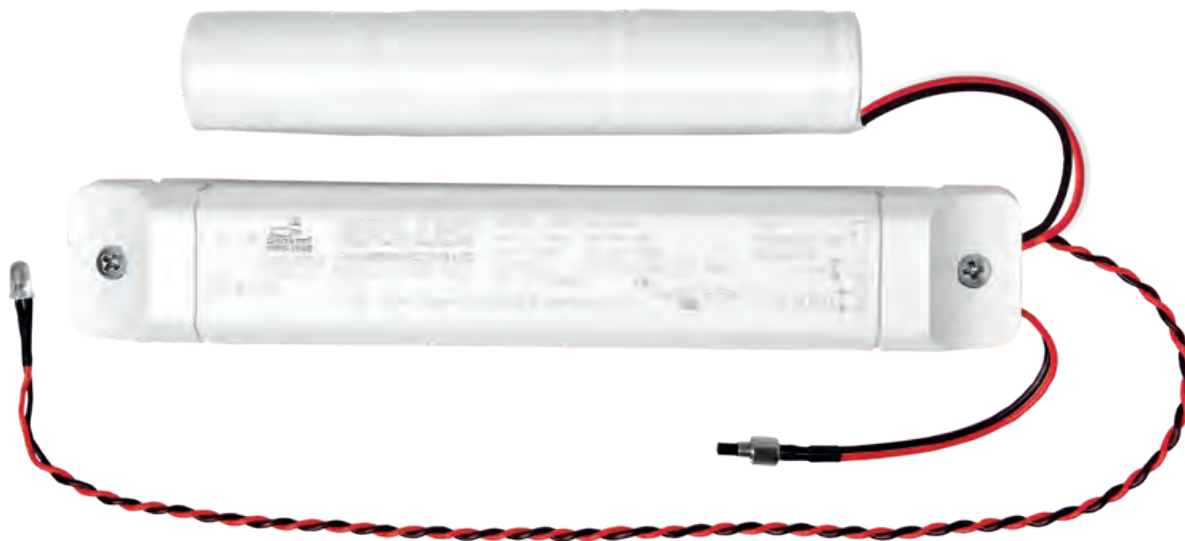

Kira Led

Driver

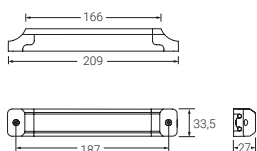

Battery

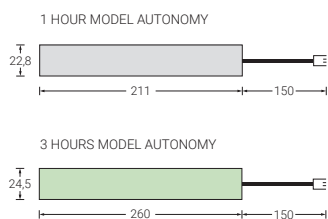

Technical features:

- Continuity lighting for LED luminaires
- Designed according to norm: EN61347-2-7.
- Charge LED.
- Power supply: 230V, 50Hz.
- Versions: Standard or Autotest
- Charging time: 24 h.
- Functioning mode: Non-maintained.
- Duration: 1 h or 3 h versions
- Batteries: NiCd (1 hour models autonomy) and NiMh with pulsing charge (3 hours models autonomy).
- Driver dimensions: 215x33,5x30 mm.
- Battery dimensions: 22,8 x 211 mm (1 hour models autonomy) y 24,5x260 mm (3 hours models autonomy)
- Class II, IP-20, IK-07
- Cable retainer.
- Protected against open circuits and shortcuts.
- Charge and status Led indicator in autotest versions.
- Includes test push button.
- Constant power output: control of the output power by microcontroller in order to adequate to the tension of the LED module connected and improve its performance (higher lumen output through the battery).
- Possibility of installation inside or outside the luminaire.
- Can withstand short circuits.

Kira Led

SELV Safety Extra-Low Voltage

INTERIOR

Estandar

IP
20

	WORKING TEMPERATURE RANGE	CHARGING CURRENT	DISCHARGING CURRENT	OUTPUT VOLTAGE RANGE	DURATION	BATTERY	INPUT POWER WITH MAINS	INPUT CURRENT WITH MAINS	OUTPUT POWER EMERGENCY	OUTPUT CURRENT EMERGENCY
SELV KXYLED-50	5°C-45°C	75-95 mA	650-900 mA	10-50 V	1 h	6 V · 1,5 Ah NiCd	1,3 W	14 mA	3,75 W	75-375 mA
SELV KXYLED3-50	5°C-45°C	200-220 mA	650-900 mA	10-50 V	3 h	6 V · 4,0 Ah NiCd	2,4 W	21 mA	3,75 W	75-375 mA
KXYLED-200	5°C-45°C	75-95 mA	650-900 mA	50-220 V	1 h	6 V · 1,5 Ah NiCd	1,3 W	14 mA	3,75 W	15-75 mA
KXYLED3-200	5°C-45°C	200-220 mA	650-900 mA	50-220 V	3 h	6 V · 4,0 Ah NiCd	2,4 W	21 mA	3,75 W	15-75 mA

Autotest

IP
20

	WORKING TEMPERATURE RANGE	CHARGING CURRENT	DISCHARGING CURRENT	OUTPUT VOLTAGE RANGE	DURATION	BATTERY	INPUT POWER WITH MAINS	INPUT CURRENT WITH MAINS	OUTPUT POWER EMERGENCY	OUTPUT CURRENT EMERGENCY
SELV KXYLEDA-50	5°C-45°C	75-95 mA	650-900 mA	10-50 V	1 h	6 V · 1,5 Ah NiCd	1,3 W	14 mA	3,75 W	75-375 mA
SELV KXYLEDA3-50	5°C-45°C	200-220 mA	650-900 mA	10-50 V	3 h	6 V · 4,0 Ah NiCd	2,4 W	21 mA	3,75 W	75-375 mA
KXYLEDA-200	5°C-45°C	75-95 mA	650-900 mA	50-220 V	1 h	6 V · 1,5 Ah NiCd	1,3 W	14 mA	3,75 W	15-75 mA
KXYLEDA3-200	5°C-45°C	200-220 mA	650-900 mA	50-220 V	3 h	6 V · 4,0 Ah NiCd	2,4 W	21 mA	3,75 W	15-75 mA

 Fittings to be installed inside of the luminaire

EXTERIOR

Standard

IP
20

	WORKING TEMPERATURE RANGE	CHARGING CURRENT	DISCHARGING CURRENT	OUTPUT VOLTAGE RANGE	DURATION	BATTERY	INPUT POWER WITH MAINS	INPUT CURRENT WITH MAINS	OUTPUT POWER EMERGENCY	OUTPUT CURRENT EMERGENCY
SELV KXYLED-50E	5°C-45°C	75-95 mA	650-900 mA	10-50 V	1 h	6 V · 1,5 Ah NiCd	1,3 W	14 mA	3,75 W	75-375 mA
SELV KXYLED3-50E	5°C-45°C	200-220 mA	650-900 mA	10-50 V	3 h	6 V · 4,0 Ah NiCd	2,4 W	21 mA	3,75 W	75-375 mA
KXYLEDA-200E	5°C-45°C	75-95 mA	650-900 mA	50-220 V	1 h	6 V · 1,5 Ah NiCd	1,3 W	14 mA	3,75 W	15-75 mA
KXYLED3-200E	5°C-45°C	200-220 mA	650-900 mA	50-220 V	3 h	6 V · 4,0 Ah NiCd	2,4 W	21 mA	3,75 W	15-75 mA

Autotest

IP
20

	WORKING TEMPERATURE RANGE	CHARGING CURRENT	DISCHARGING CURRENT	OUTPUT VOLTAGE RANGE	DURATION	BATTERY	INPUT POWER WITH MAINS	INPUT CURRENT WITH MAINS	OUTPUT POWER EMERGENCY	OUTPUT CURRENT EMERGENCY
SELV KXYLEDA-50E	5°C-45°C	75-95 mA	650-900 mA	10-50 V	1 h	6 V · 1,5 Ah NiCd	1,3 W	14 mA	3,75 W	75-375 mA
SELV KXYLEDA3-50E	5°C-45°C	200-220 mA	650-900 mA	10-50 V	3 h	6 V · 4,0 Ah NiCd	2,4 W	21 mA	3,75 W	75-375 mA
KXYLEDA-200E	5°C-45°C	75-95 mA	650-900 mA	50-220 V	1 h	6 V · 1,5 Ah NiCd	1,3 W	14 mA	3,75 W	15-75 mA
KXYLEDA3-200E	5°C-45°C	200-220 mA	650-900 mA	50-220 V	3 h	6 V · 4,0 Ah NiCd	2,4 W	21 mA	3,75 W	15-75 mA

 Fittings to be installed outside of the luminaire



Kenlux

Technical features:

- Kit for conversion in emergency lighting.
- Reference Norm: EN 60924.
- Charge signaling with a LED.
- Power 230V, 50/60 Hz.
- Charging time 24 hours.
- Possibility of remote control.

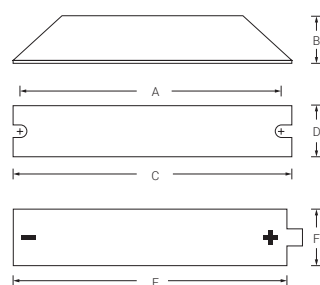

	A	B	C	D	E	F
KEN 1-18	163	32	173	39	127	22
KEN 3-18	163	32	173	39	176	33
KEN 1-36	163	32	173	39	127	22
KEN 3-36	163	32	173	39	176	33
KEN 1-58	163	32	173	39	169	22
KEN 3-58	163	32	173	39	235	33
KEN S1UNIV	163	32	173	39	295	33
KEN 1-14 T5	163	32	173	39	353	33
KEN 1-21 T5	163	32	173	39	353	33
KEN 1-24 T5	163	32	173	39	353	33
KEN 1-28 T5	163	32	173	39	353	33
KEN 1-35 T5	163	32	173	39	353	33
KEN 1-39 T5	163	32	173	39	353	33
KEN 1-49 T5	163	32	173	39	353	33
KEN 1-54 T5	163	32	173	39	353	33
KEN1-UNI	41	239	44	295	33	

Kenlux

Standard

	BATTERY	AUTONOMY	BALLAST LUMEN FACTOR	PACKAGING
KEN1-18	3,6 V · 1,5 Ah	18W: 1 h	18W: 17%	20
KEN3-18	3,6 V · 4,0 Ah	18W: 3 ho	18W: 12%	20
KEN1-36	3,6 V · 1,5 Ah	36W: 1 h	18W: 17% - 36W: 8%	20
KEN3-36	3,6 V · 4,0 Ah	36W: 3 h	18W: 17% - 36W: 8%	20
KEN1-58	4,8 V · 1,5 Ah	58W: 1 h	58W: 8%	20
KEN3-58	4,8 V · 4,0 Ah	58W: 3 h	58W: 6,5%	20
KENS1-UNI	6,0 V · 4,0 Ah	18W: 2 h 36W: 1,5 h 58W: 1 h	18W: 39% 36W: 25% 58W: 18%	20
KEN1-14T5	7,2 V · 4,0 Ah	14W TL5 HE: 1 h	14W TL5 HE: 63%	20
KEN1-21T5	7,2 V · 4,0 Ah	21W TL5 HE: 1 h	21W TL5 HE: 51%	20
KEN1-24T5	7,2 V · 4,0 Ah	24W TL5 HO: 1 h	24W TL5 HO: 44%	20
KEN1-28T5	7,2 V · 4,0 Ah	28W TL5 HE: 1 h	28W TL5 HE: 42%	20
KEN1-35T5	7,2 V · 4,0 Ah	35W TL5 HE: 1 h	35W TL5 HE: 31%	20
KEN1-39T5	7,2 V · 4,0 Ah	39W TL5 HO: 1 h	39W TL5 HO: 26%	20
KEN1-49T5	7,2 V · 4,0 Ah	49W TL5 HO: 1 h	49W TL5 HO: 24%	20
KEN1-54T5	7,2 V · 4,0 Ah	54W TL5 HO: 1 h	54W TL5 HO: 21%	20









Intelligent DALI

Compatible with **NormaLINK** 

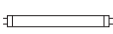
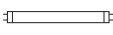

	BATTERY	AUTONOMY	BALLAST LUMEN FACTOR	PACKAGING
KEN1-UNI	6,0V 4,0Ah	18W: 2 h 36W: 1,5 h 58W: 1 h	18W: 39% 36W: 25% 58W: 18%	20

KENS1-UNI. Compatibility and duration

	LAMP	PLAMP (W/h)	THEORETICAL LUMEN OUTPUT	BLF	LUMEN OUTPUT (lm)
	TC-DEL 18W	18	1200	43%	510
	TC-DEL 26W	26	1800	34%	604
	TC-TEL 18W	18	1200	37%	445
	TC-TEL 32W	32	2400	24%	584
	TC-TEL 42W	42	3200	23%	733
	T8-18W	18	1350	39%	528
	T8-36W	36	3350	24%	806
	T8-58W	58	5200	18%	951
	T5-HE 14W	14	1350	41%	548
	T5-HE 21W	21	2100	39%	822
	T5-HO 24W	24	2000	32%	643
	T5-HO 39W	39	3500	26%	902
	TC-L 18W	18	1200	31%	367
	TC-L 24W	24	1800	34%	604
	TC-L 36W	36	2900	28%	810
	TC-L 55W	55	4800	19%	894
	TC-F 18W	18	1100	21%	230
	TC-F 24W	24	1700	19%	328
	TC-F 36W	36	2800	21%	596
	TC-DD 21W	21	1500	37%	550
	TC-DD 28W	28	2050	32%	665
	FC-22W	22	875	38%	332
	FC-32W	32	1550	34%	528
	FC-40W	40	2090	34%	709

*BLF: Percentage of luminic power emitted / nominal luminic power of the lamp.

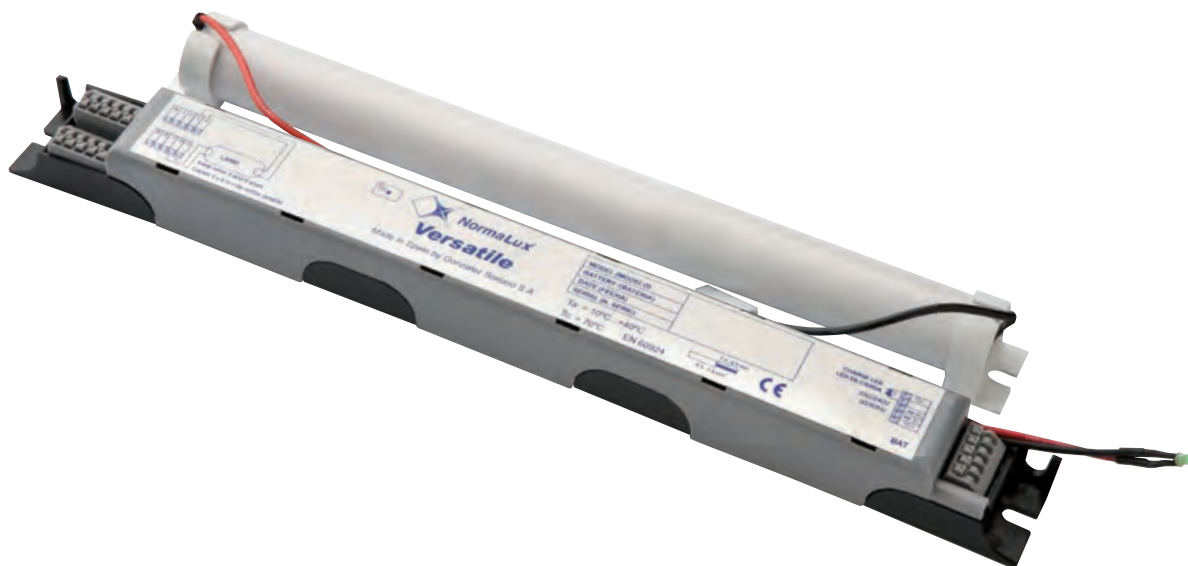

Versatile

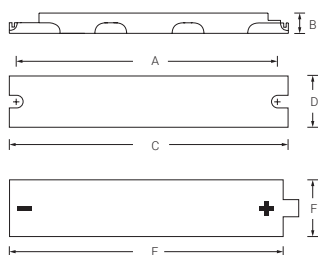

Technical features:

- 230V 50/60 Hz.
- Norms EN 55015, EN 61347-2-7, EN 61000-3-2.
- Low Power Directive EC 72/23/CE.
- Electromagnetic Compatibility Directive 2004/108/CE.
- Temperature: 10°C a 40°C.
- Batteries: two options available changing the position of an internal bridge:
 - Batteries Ni/Cd de 7.2V/1.5Ah 1 h Autonomy.
 - Batteries Ni/Cd de 7.2V/4 Ah 3 h Autonomy.
- Physical features:
 - Size: 316 mm x 32mm x 25 mm (height)
 - Housing: Polycarbonate plastic.
 - Cage clamps in the input and output for lamps and connection to electronic ballast.
- Others:
 - Green Led to show the correct charge of the batteries.
 - Compatible with all the electronic ballasts.
 - Compatible with Normalux' remote control S-TE.
- Lamps:
 - Can be used with all fluorescent lamps from 18W to 58W







	A	B	C	D	E	F
VKIT	316	25	32	304	255	23
VKIT3	316	25	32	304	360	33

Versatile

IP 20

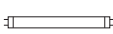
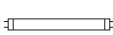
	BATTERY	AUTONOMY	PACKAGING
VKIT	7,2 V · 1,5 Ah	1 h	20
VKIT3	7,2 V · 4,0 Ah	3 h	20

VERSATILE. Compatibility and duration

	LAMP	PLAMP (W/h)	THEORETICAL LUMEN OUTPUT	BLF	LUMEN OUTPUT (lm)
	TC-DEL 18W	18	1200	18%	220
	TC-DEL 26W	26	1800	16%	286
	TC-TEL 18W	18	1200	16%	191
	TC-TEL 32W	32	2400	9%	219
	TC-TEL 42W	42	3200	10%	320
	T8-18W	18	1350	14%	195
	T8-36W	36	3350	10%	342
	T8-58W	58	5200	7%	366
	T5-HE 14W	14	1350	20%	274
	T5-HE 21W	21	2100	14%	300
	T5-HE 28W	28	2900	14%	415
	T5-HO 24W	24	2000	14%	274
	T5-HO 39W	39	3500	11%	377
	T5-HO 54W	54	5000	8%	389
	T5-HE 35W	35	3650	12%	437
	TC-L 18W	18	1200	13%	152
	TC-L 24W	24	1800	15%	262
	TC-L 36W	36	2900	11%	320
	TC-L 55W	55	4800	10%	457
	TC-F 18W	18	1100	10%	110
	TC-F 24W	24	1700	11%	195
	TC-F 36W	36	2800	10%	276
	TC-DD 21W	21	1500	15%	218
	TC-DD 28W	28	2050	14%	284
	FC-22W	22	875	17%	147
	FC-32W	32	1150	18%	211
	FC-40W	40	2090	13%	282

*BLF: Percentage of luminic power emmitted / nominal luminic power of the lamp.

Accessories

Remote controls

S-TE Remote control for up to 300 fittings standard or autotest

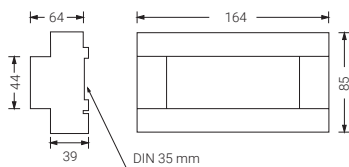



Emergency lights for elevators

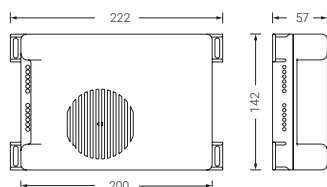

Emergency light for elevators, which includes an acoustic alarm, maintained output of 6v maximum 40mA and potential free relay: 10A, $\cos = 1 \varphi$



	LUM	BALLAST LUMEN FACTOR	LAMP	AUTONOMY	BATTERY	CONSUMPTION	ALARM		COS (φ)	PACKAGING
ASI	130 lm		2x6V 200m A E-10	1 h	6,0V 1,5Ah	3 W	90 dB - 1 mts	0,9	0,8	1
ASFL-18		24	TL-D 18 W	1 h	6,0V 1,5Ah	3 W	90 dB - 1 mts	0,9	1,1	1
ASFL-36		12	TL-D 36 W	1 h	6,0V 1,5Ah	3 W	90 dB - 1 mts	0,9	0,8	1
ASD	30 lm		QT-6 10W	1 h	6,0V 4,5Ah	3 W	90 dB - 1 mts	0,9	1,4	1



PLEMP

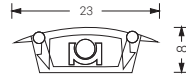

PLEMP

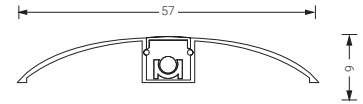

PLUNI



PLUNI

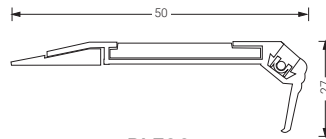

PLESC

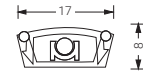

PLSUP



PLESC

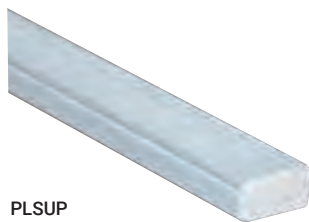

PLSUP

Light paths

LED path light manufactured in aluminium with multiple uses: corridors, stairs, theatres or malls. Powered at 24v DC, are compatible with the C24-100 and C24-300 central battery systems (up to 400 meters with C24-100 model and up to 1200 meters with C24-300 model).

CE

Four light paths available:

IP
20

		W/m	m (C24-100M)	m (C24-300M)
PLEMP	Recessed	0,25	400	1200
PLUNI	Joint	0,25	400	1200
PLESC	Stair	0,25	400	1200
PLSUP	Surface	0,25	400	1200

Connection specifications with C24 centrals:

- Maximum power per output: 80 W
- Distance between derivations: maximum 20 m.
- Several derivations can be connected to the same output.

and four terminal covers:

PLTEMP	Embedded mounted path light end cap
PLTUNI	Union path light end cap
PLTESC	Stair path light end cap
PLTSUP	Surface mounted path light end cap

NormaLINK 

App control by Normagrup



What is Normalink?

Normalink is an advanced system to control general lighting and monitor emergency lighting (emergency luminaires and exit signs).

Normalink provides control via the following applications:

Normalink App
for IOS or Android.
Also available for
computers
compatible
with Windows.



iOS   Windows

Control via
Normalink BMS drawings
for computers compatible
with Windows.

Via the **BMS** (Building
Management System)
software compatible
with the Modbus/IP
protocol.





NORMALINK COMPATIBILITY

Compatible with DALI general lighting and emergency lighting.

Compatible with Normalux⁽³⁾ INTELLIGENT WIRELESS emergency lighting and exit signs.

Compatible with SALUZ Tunable White⁽¹⁾ luminaires and other DALI DT8⁽²⁾ equipment.

Compatible with Modbus/IP⁽⁴⁾.

⁽¹⁾ SALUZ Tunable White is a technology developed by Normalit that offers luminaires providing healthy lighting that are connected to the DALI line and can be controlled via Normalink.

⁽²⁾ DALI DT8 or DALI Device Type 8 is the DALI luminaire that enables the tunable white to be controlled via a single DALI address.

⁽³⁾ INTELLIGENT WIRELESS is the technology developed by Normalux in accordance with the IEC 62386-104 Standard that enables wireless communication between emergency luminaires or exit signs that is compatible with this technology.

⁽⁴⁾ Modbus/IP is a standard protocol that enables Normalink to be integrated in a supervision system (SCADA or BMS).



Main functions of Normalink

With Normalink, you can explore all of the lighting possibilities for a room, establishment or building, making it more human, efficient, practical and safe.

● Create Environments

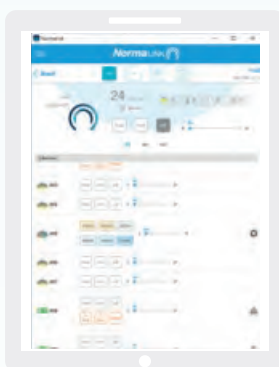

Control Tunable White.



Group configuration.

Control each light point individually, by DALI groups or even by virtual groups of luminaires from different DALI lines.

Group luminaires together and define scenarios (light levels) in accordance with the needs of each room.

Create time settings for the fittings to turn on, turn off or create scenarios.

Set the light level and even the colour temperature of the luminaires with tunable white control.

NEW FEATURE!

Simulation of circadian cycles that enables healthy and comfortable environments to be created.

NEW FEATURE!

Integrate external elements

Integrate push buttons, switches, presence sensors, light regulators, entrance/exit signs or even control traditional lighting on/off has never been so easy with the different Normalink devices.

Normalink integration.



Normalink BMS control software.

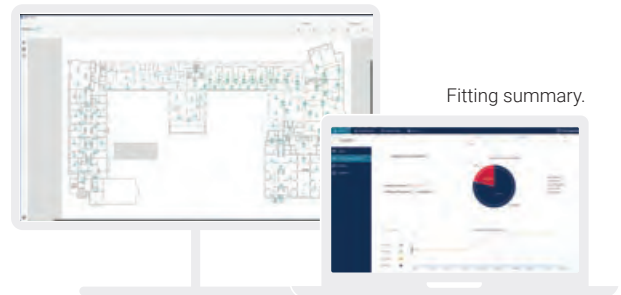

Fitting summary.

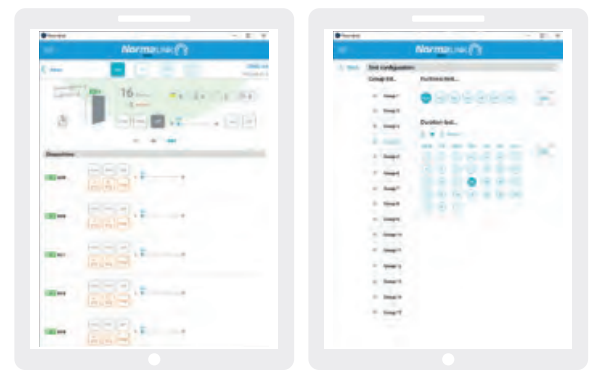

Control of emergency lighting.

Test configuration.

Integrate external elements

Monitor the status of the emergency lighting fitting and exit signs in real time.

Detection and notification of any anomaly. It also reports faults in the general lighting.

Automatic log.

Normalink is compatible with C24i central battery systems.

Compatible with autonomous SATI Addressable emergency lighting (IDALING gateway required).

Normalink BMS for exhaustive monitoring.

NEW FEATURE!

The Normalink ecosystem

A system that you can trust

Simple DALI wiring, without polarity and isolated (robust communication without any surprises).

Scalable system, ideal for small, medium or large installations.

Quick and simple commissioning.



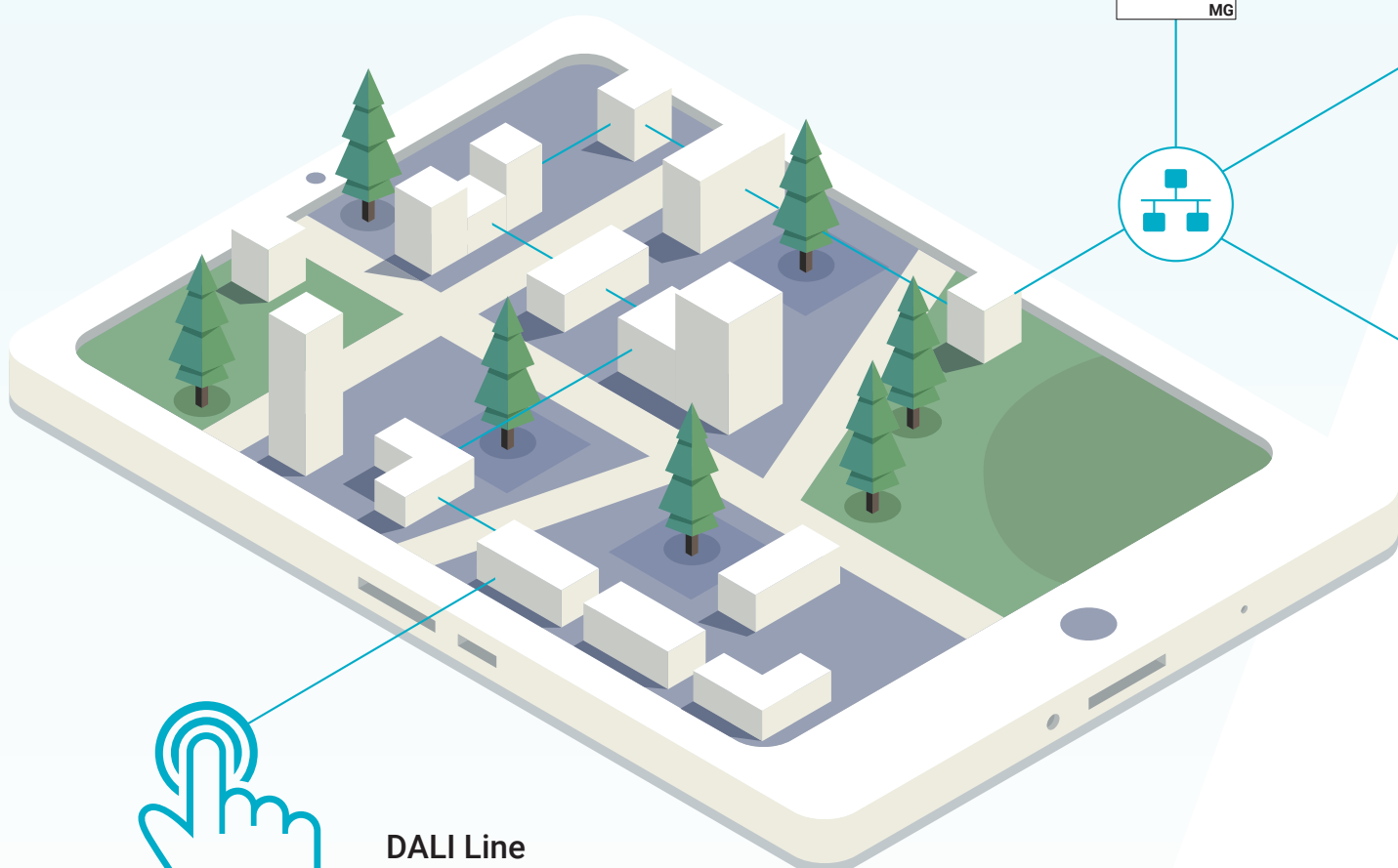
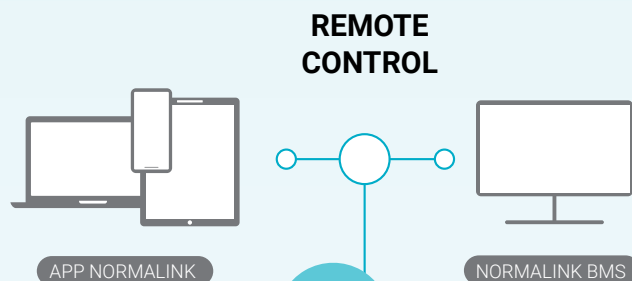



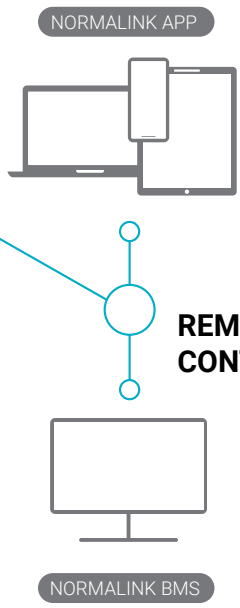
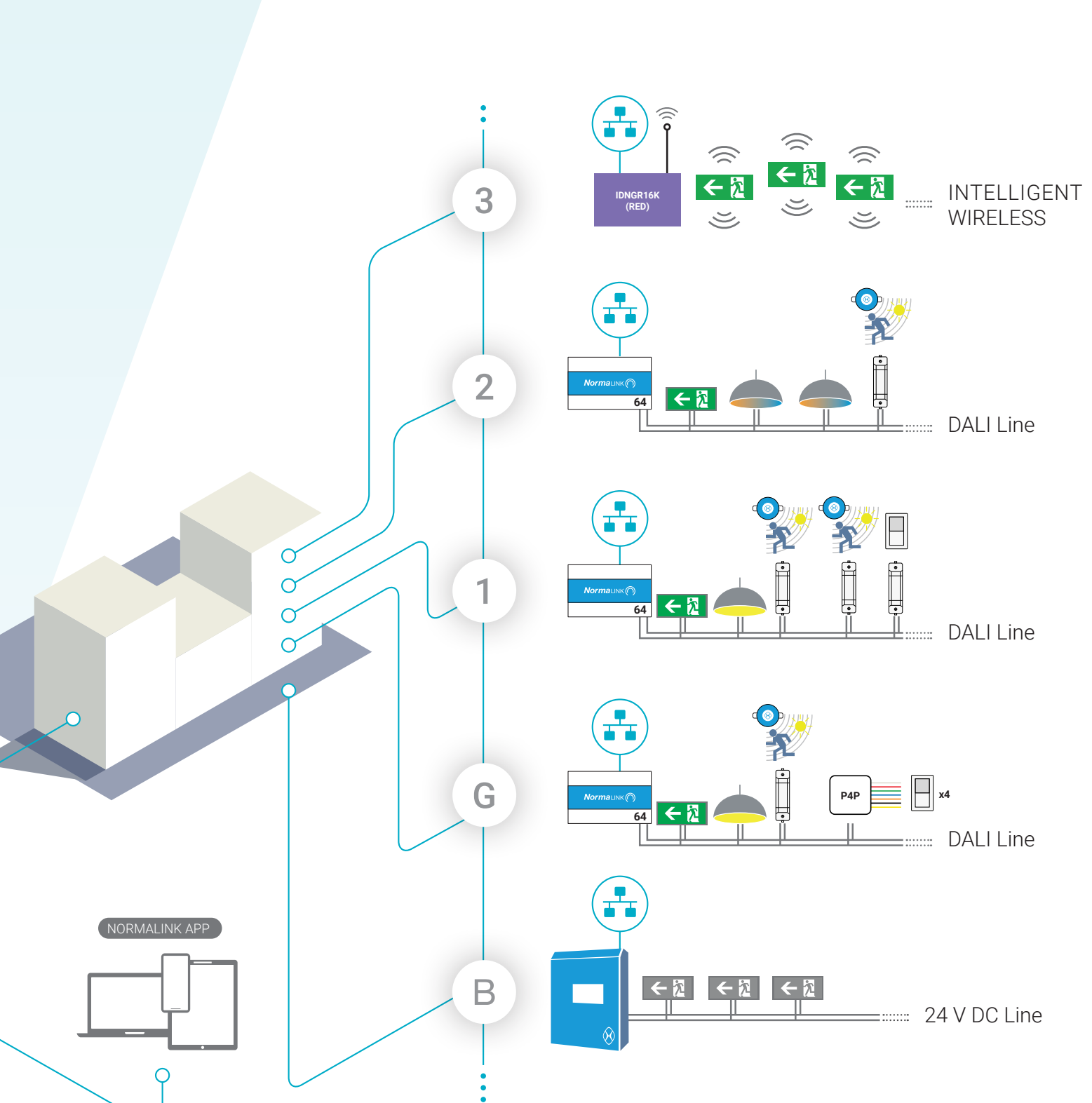



Universal external elements (light regulators, presence detectors, push buttons, external signals, etc.) are directly connected to the DALI line via adapters (without the need for a DALI address).



DALI Line
2x1,5 mm²
Max. 300 m



REMOTE CONTROL

-  DALI-TCP/IP Gateway (Ref. IDNG-64)
-  TCP/IP master gateway (Ref. IDNG-MG)
-  Adapter for push buttons, presence sensors and light regulators (Ref. IDNG-EAD)
-  DALI Luminaire
-  SALUZ TW / DALI DT8 Luminaire
-  DALI Emergency Luminaire
-  Luminaire for C24i central battery systems
-  Self contained emergency INTELLIGENT block WIRELESS NORMALUX
-  Push buttons (Ref. IDNG-P4P)
-  Light regulators (Ref. ILSR110/ILSS110)
-  Central Battery System (Ref. C24i-300)

Normalink TW

Now it is possible to control DALI DT8 and SALUZ Tunable White luminaires with Normalink and to create healthier and more comfortable environments.



It is possible to simulate circadian cycles (up to 32) and modify them (intensity and colour temperature) by time blocks.



Push buttons, presence sensors and/or light regulators which can also act on the programmed circadian cycles.



Control and configuration from Normalink APP and Normalink BMS.



In addition to the IDNG64 gateways in accordance with the number of DALI luminaires, this new function also requires an IDNG-MG gateway connected to the same local network which will act as the system's switchboard.

EXAMPLE

Example of the control of circadian cycles via the IDNG-P4P with capacity for four push buttons:

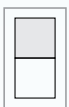

1

Push button 1:
ON/OFF lighting and pre-defined circadian cycle.

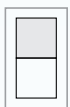

2

Push button 2:
Regulation of the colour temperature.

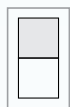

3

Push button 3:
Regulation of the amount of light and the switching on/off of the luminaires.

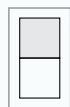

4

Push button 4:
"Siesta" scene in which all of the luminaires are set to a colour temperature of 2700 °K and light intensity of 10%.



SaLuz® Video

Further information >
sa-luz.com

SaLuz® is a registered trademark.

SaLuz® technology is protected by
Utility Model Number 201931533.



Configuration of circadian cycles.

SaLUZ[®]

SaLuz[®] technology is inspired by natural light.

Light affects our vital rhythms, our physiological processes, our mood, our capacity to concentrate, our emotions and, of course, our health.

Although artificial lighting is extremely useful, our biology is still programmed to adapt to natural light, its cycles and characteristics.



Automatically adapts to the circadian rhythm.



Controls flickering (below 8%).



Controls photobiological safety.

VERSIONS:

HAT HR SALUZ[®]



NASSEL AVANT SALUZ[®]



TRAZZO AVANT SALUZ[®]



VERSION COMPATIBLE WITH NORMALINK:

SaLUZ[®] Tunable white

This version enables circadian cycles to be modified remotely via Normalink and adapted to the specific needs of the project.

Normalink and emergency lighting / exit signs

Normalink is a platform designed to control and monitor safety lighting.



Control and monitoring of each of the self contained blocks of emergency lighting and exit signs.

Monitoring and control of the emergency luminaires and/or beacons connected to C24i central battery systems.

Programming of functional and autonomy tests as per the standard EN 50172.

Anomalies warning.

Interaction with other safety systems.

Integration in SCADA control systems using MODBUS/IP.

Programming of scenes and time settings for emergency lighting that is functioning permanently.

Control of the light source in maintained mode.

Simple DALI addressing via Normalink code (check availability).



Normalink BMS

Normalink BMS allows for monitoring from any computer connected to the same local network as the other Normalink elements. (Gateways with DALI luminaires, C24i central battery systems with emergency luminaires at 24 V DC, input- output modules,...). Remote monitoring is also possible thanks to **Normalink Cloud** 

Monitor and control general DALI lighting, self contained DALI emergency lighting and C24i central battery systems.

Connection to the local network or remotely via Normalink Cloud.

Anomalies warning (by type, quantity, time, etc.).

Notifications sent by e-mail.

Customisation of reports.

Test configuration (functional and annual).

Performance of tests (functional and annual).

Creation and control of groups, scenes and timings.

Log of events and tests.

Global vision of the building with a fittings and anomalies counter.

Development module for project creation.

Automatic recognition of all the devices compatible with Normalink in the local network (gateways, i/o modules, central battery systems).

Multi-user system.



Normalink BMS

Normalink BMS takes pride on its two different modules: One for supervision / control and another one to be developed from scratch and customizable.

Control module



- Browsing by drawings.
- Real time status.
- Identification of incidents by type (light source, battery, autonomy, communication).
- Filtering by type of incident.
- Control of groups, macro-groups and scenes.
- Individual control of each luminaire. Control of the maintained status (on, off and dim), remote control, performance of tests, etc.
- Reports management tool.
- Annual events calendar.
- Search tool for luminaires in the drawing.
- Notifications management tool.

Development module

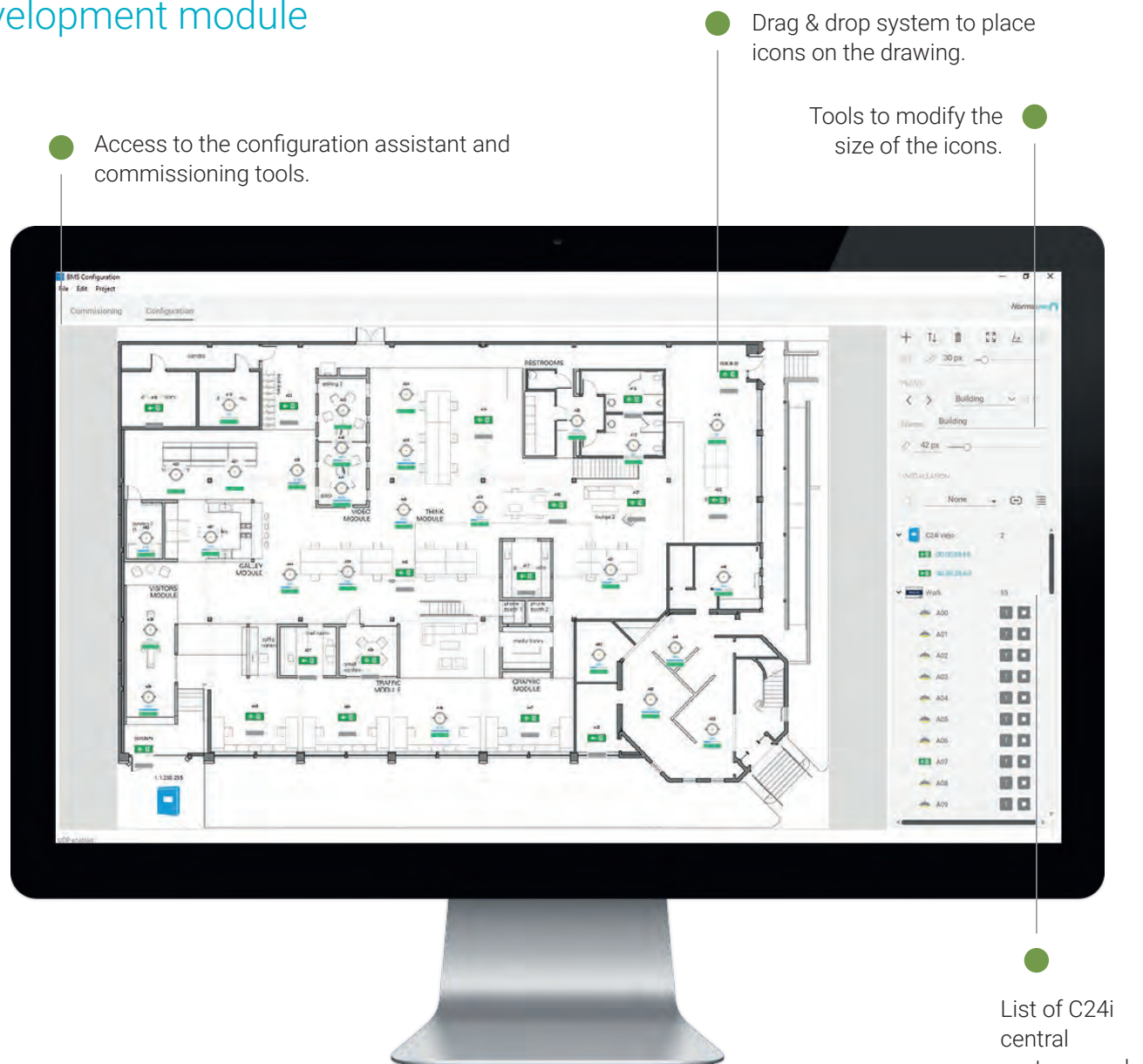

- Step-by-step configuration assistant. Simple and intuitive.
- Tools for centralised commissioning.
- Customised reports editor.

- Drag & drop system for project development.
- Modification of the size of icons according to the plan of the building.

Normalink WIRELESS

Normalink is now compatible with Intelligent Wireless emergency lighting devices by Normalux.

Normalux Families with Intelligent Wireless version:

● VIA R



● VIA R IP65



● EXTRALINE



● EUROPRISMA

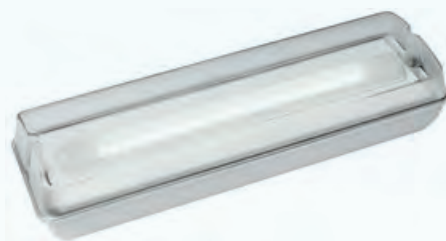

● EXCELLENCE



Check out for other product ranges.

AUTONOMOUS
EMERGENCY
LIGHTING

**Intelligent
Wireless**

AUTONOMOUS
EMERGENCY
LIGHTING



PHYLOSOPHY

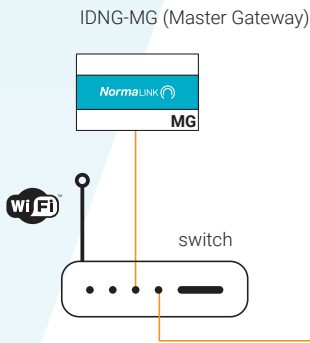

CONTROL CAPACITY BY NETWORK

Up to 250 sub-networks.
Up to 64 emergency luminaires per sub-network.
Total: 16,000 emergency luminaires.



SUB-NETWORK
(Up to 64 Intelligent Wireless autonomous emergency blocks)

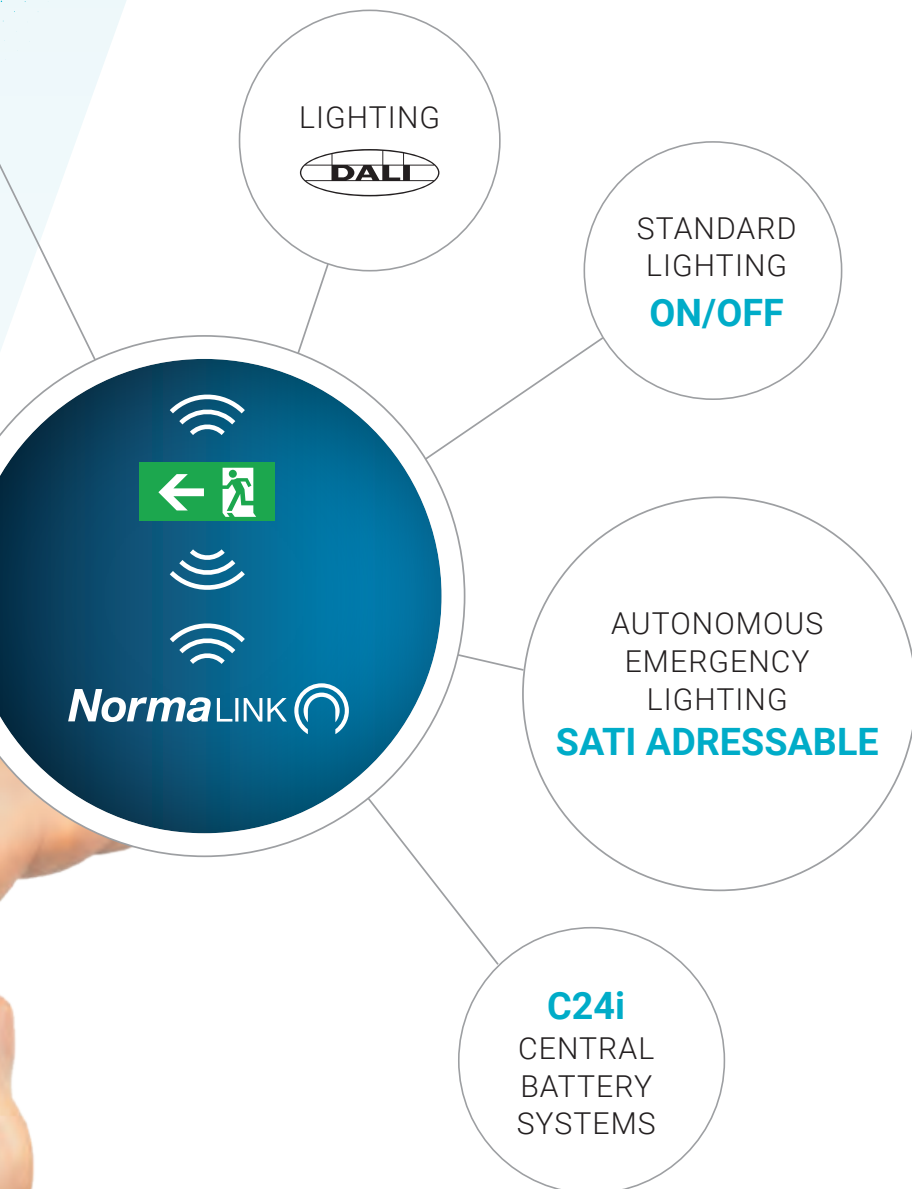

The **Intelligent Wireless system by Normalink** is based on a wireless link with ethernet connection (Ref. IDNGR16K) capable of controlling up to 16,000 Normalux emergency luminaires compatible with the Intelligent Wireless version.

This wireless link is connected directly to the local network and requires a master gateway in order to function.

TECHNICAL FEATURES

- Capacity: Up to 16,000 Intelligent Wireless emergency luminaires by Normalux per radio link.
- Capable of creating 250 sub-networks per wireless link.
- Up to 64 Intelligent Wireless emergency luminaires by Normalux per sub-network.
- MultiMesh 868 Mhz technology compatible with the DALI IEC 62386-104 Standard.
- IDNG-MG master gateway is required in order to function.
- Possibility of linking up to 250 radio links per master gateway.
- Maximum open field range of 250 metres in communication:
 - Wireless link - luminaire.
 - Luminaire - luminaire.
- Maximum indoor range: 50 metres (2-3 walls, 2 floors).
- Each emergency luminaire also functions as a repeater of the wireless signal via a configurable system of jumps.

Multi-jump repetition system to increase the range between luminaires.

Normalink Devices

IDNG-MG



TCP/IP master gateway for the control of Normalink installations. Configuration through the incorporated webserver. Once connected to the same local network as the rest of the Normalink devices, the Master gateway will take control of the installation allowing:

- Ethernet connection.
- Configure notifications.
- The installation to be controlled remotely thanks to the Normalink Cloud service.
- Comprehensive control of the installation thanks to the Normalink BMS software with drawings (included in the Gateway).
- Control the installation from external software with Modbus IP support.
- DIN Rail mounting (12 modules).
- Power Supply: 230V AC 50-60Hz from an UPS (Uninterrupted Power Supply).
- Dimensions: 210 x 90 x 60 mm.



IDNGR16K



Normalink IDNGR16K wireless link. TCP/IP wireless link that enables Normalink to control luminaires compatible with the Normagrup INTELLIGENT WIRELESS system. Capacity for 250 sub-networks.

Each sub-network may consist of up to 64 Normagrup INTELLIGENT WIRELESS luminaires with pre-programmed default addresses (from A0 to A63).

- It has a web server for the configuration of the network parameters.
- An IDNG-MG master gateway is required for its control (maximum capacity 250 IDNGR16K per master gateway).
- Wireless "multimesh" technology based on 868 Mhz.
- Maximum open field distance: 250 metres.
- Maximum indoor range: 50 metres (2-3 walls, 2 floors).
- Manufactured in accordance with DALI IEC 62386 Standard.
- 5 V DC power supply via an external power source (included).
- Dimensions: 80 x 115.1 x 27.4 mm.

Multi-jump repetition system to increase the range between luminaires.



IDNG-64



DALI-TCP/IP gateway for control via Normalink of up to 64 general lighting and/or emergency lighting luminaires as per the DALI (Digital Addressable Lighting Interface) Standard.

- Dimensions: 105 x 90 x 60 mm.
- Ethernet connection.
- DIN Rail mounting (6 modules).
- Incorporates an internal power supply to power the DALI line and a CR2032 battery to avoid losing information.
- Power Supply: 230V AC 50-60Hz from an UPS (Uninterrupted Power Supply).
- Additionally, this device enables the connection, via the DALI line, of up to 16 devices with the Normalink code (Ref. IDNG-EAD and IDNG-P4P).



IDNG-EAD

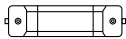

Adapter to integrate non-DALI control devices, such as push buttons, presence sensors and light regulators, into the DALI line.

- It has a DALI connector, 0-10 V analogue input (non-isolated) and a digital input (230 V AC).
- Automatic detection and configuration from the Normalink app.
- Powered via the DALI bus.
- Does not use a DALI address.
- Identification via Normalink code.
- Dimensions: 215 x 33.5 x 30 mm.

IDNG-P4P



Interface for the connection of four push buttons or a switch (potential-free) to a DALI line and its integration in the Normalink system.

- Connection to the DALI line.
- Four inputs or channels (IN0, IN1, IN2 and IN3) and a shared terminal.
- Powered by section wires of 0.5 mm² and 200 mm long.
- Terminals IN1, IN2, IN3 and IN4 cannot be extended using an extra wire.
- Automatic detection and configuration from the Normalink app.
- Powered from the DALI bus.
- Does not use a DALI address.
- Identification via Normalink code.
- Dimensions 50 x 50 mm.

Normalink Devices

ILSR110

1/10V DC **closed loop constant light regulator** for connection to Normalink IDNG-EAD adapter.



- Mounted in false ceiling. Incorporates a movement sensor (PIR) allowing the activation of the lighting when people are present, if required.
- Power Supply: 230 V AC 50 Hz.
- Brightness level: 100~1000 lux.
- Connection Time: 10-30 min.
- IP 20 as per UNE 20324.
- Operating temperature: 0°C to 40°C.
- Movement detection range: 360°/day. 7 m at a height of 2.5 m.
- Diameter: 80 mm.
- Controller dimensions: 107x53x34 mm.
- Manufactured as per UNE EN 60730 Standard.

ILSS110

1/10V DC **closed loop constant light regulator** for connection to Normalink IDNG-EAD adapter.



- Surface ceiling mounted. Incorporates a movement sensor (PIR), allowing the activation of the lighting when people are present, if required.
- Power Supply: 230 V AC 50 Hz
- Brightness level: 100~1000 lux.
- Connection Time: 10-30 min.
- IP 20 as per UNE 20324.
- Operating temperature: 0°C to 40°C.
- Movement detection range: 360°/day. 7 m at a height of 2.5 m.
- Diameter: 118.5 mm.
- Height: 45 mm.
- Manufactured as per UNE EN 60730 Standard.





IDNG-10ES



Input / output module compatible with the Normalink system. Allows the direct integration of external input / output elements to Normalink (not through DALI).

- Dimensions: 105 x 90 x 60 mm.
- 10 terminals that can be programmed as inputs or outputs.
- One relay output.
- Ethernet connection.
- Web server for network configuration.
- Potential-free inputs for the connection of push buttons, switches or signals.
- 24v outputs for connecting relays, solid state contactors or external devices (PLCs, switchboards or others). Maximum current output 10mA.
- Identification via Normalink code.
- DIN Rail mounting (6 modules).
- Power Supply: 230V AC 50-60Hz form an UPS (Uninterrupted Power Supply).



Sales Terms and Conditions

- Consult RRP prices of Normalink devices.
- The sale of the Normalink system, its devices and the provision of the commissioning service (Ref. ISS) is subject to the purchase of Normalit technical lighting and/or Normalux emergency lighting.

Surface covered with 1 lux

VIA LED

INSTALLATION HEIGHT (meters)	VSI VMSI VTS VCS I VLS I VLSL
2,0 m	36,48
2,5 m	45,36
3,0 m	52,81
3,5 m	55,41
4,0 m	58,08
5,0 m	51,58

DUNNA MAINTAINED LED

INSTALLATION HEIGHT (meters)	DL-100	DL-150	DL-200	DL-300	DL-400
2,0 m	24,63	30,19	36,31	47,48	50,46
2,5 m	26,42	32,67	38,48	55,41	61,02
3,0 m	28,27	35,25	45,36	60,82	69,59
3,5 m	34,21	37,23	47,48	66,47	81,91
4,0 m	19,63	38,48	50,26	76,97	86,79
5,0 m	16,61	36,31	44,17	81,71	95,23

DUNNA NON-MAINTAINED MULTILED

INSTALLATION HEIGHT (meters)	D-60L	D-100L	D-150L	D-200L	D-300L	D-400L	D-500L	D-600L	D-700L
2,0 m	15,13	22,90	26,42	34,21	47,78	53,72	59,06	67,73	76,35
2,5 m	18,09	26,42	28,27	39,52	55,41	63,49	70,68	84,46	93,10
3,0 m	15,20	28,27	33,14	42,88	63,61	70,81	80,04	91,48	100,09
3,5 m	12,56	27,23	35,56	45,23	70,88	78,41	87,96	103,67	111,02
4,0 m	10,17	24,63	36,31	46,49	78,53	86,39	96,57	112,65	120,48
5,0 m		22,90	34,21	46,36	84,53	91,48	109,07	128,39	142,95

DUNNA MAINTAINED MULTILED

INSTALLATION HEIGHT (meters)	DL-60M	DL-150M	DL-200M	DL-300M
2,0 m	15,78	26,72	29,15	44,86
2,5 m	18,74	28,57	35,18	53,07
3,0 m	15,85	33,44	37,56	61,69
3,5 m	13,21	35,86	39,52	69,03
4,0 m	10,82	36,61	41,78	72,93
5,0 m		34,51	38,34	80,23

STYLO MAINTAINED MULTILED

INSTALLATION HEIGHT (meters)	SL-60M	SL-150M	SL-200M	SL-300M
2,0 m	18,35	32,16	34,21	40,71
2,5 m	21,58	34,21	40,71	52,81
3,0 m	22,06	40,71	43,05	60,82
3,5 m	21,23	43,00	45,36	63,61
4,0 m	18,09	41,80	50,26	67,39
5,0 m	8,04	36,31	52,81	72,56

STYLO NON-MAINTAINED MULTILED

INSTALLATION HEIGHT (meters)	S-30L	S-60L	S-100L	S-150L	S-200L	S-300L	S-400L	S-500L
2,0 m	10,17	16,61	24,63	28,27	34,21	47,78	52,81	60,82
2,5 m	11,34	18,09	28,27	33,18	40,71	55,41	66,47	72,38
3,0 m	9,07	18,85	30,19	35,25	45,36	66,47	75,65	84,94
3,5 m	3,08	15,2	32,16	38,48	50,26	73,89	84,94	98,52
4,0 m	-	13,85	31,45	39,59	52,81	78,53	88,24	105,68
5,0 m	-	-	23,75	35,25	49,01	84,94	98,52	116,89

GS NON-MAINTAINED

INSTALLATION HEIGHT (meters)	G-60L	G-100L	G-150L	G-200L	G-300L	G-400L	G-500L
2,0 m	15,20	24,63	28,27	34,21	45,36	52,81	60,82
2,5 m	18,09	27,33	32,16	40,71	55,41	63,62	75,42
3,0 m	18,22	30,19	36,31	45,36	63,61	75,42	84,94
3,5 m	14,55	28,27	37,39	47,78	69,39	84,94	91,60
4,0 m	11,30	26,42	38,48	50,26	75,42	88,24	105,68
5,0 m	-	18,15	32,16	46,56	78,53	98,52	116,89

GS MAINTAINED

INSTALLATION HEIGHT (meters)	GL-60	GL-150	GL-200	GL-300
2,0 m	15,50	28,38	34,32	45,36
2,5 m	18,30	32,22	40,89	55,41
3,0 m	18,38	37,11	45,41	60,82
3,5 m	14,62	37,95	47,84	66,47
4,0 m	11,50	39,02	50,43	72,38
5,0 m	-	32,53	46,62	75,42



See complete information on
web www.normalux.com

HERMETIC LED

INSTALLATION HEIGHT (meters)	DEL-60	DEL-150	DEL-200	DEL-300
2,0 m	21,20	25,51	32,04	45,31
2,5 m	22,87	26,29	39,52	51,46
3,0 m	23,72	27,27	45,23	57,96
3,5 m	22,43	30,15	45,94	66,35
4,0 m	20,82	27,33	44,10	69,27
4,5 m	18,84	25,51	42,97	72,25

HERMETIC LED NON-MAINTAINED

INSTALLATION HEIGHT (meters)	DE-60L	DE-100L	DE-150L	DE-200L	DE-300L	DE-400L	DE-500L	DE-600L
2,0 m	13,1	17,8	28,0	33,1	45,2	52,5	59,1	75,2
2,5 m	15,2	20,5	29,9	37,3	54,0	63,5	69,9	89,5
3,0 m	14,5	21,1	31,2	42,8	63,5	70,7	78,4	93,11
3,5 m	12,2	24,5	33,2	44,1	70,6	75,5	84,2	102,3
4,0 m	7,00	24,0	32,1	45,3	73,7	83,2	92,2	110,83
5,0 m	-	20,4	29,2	44,1	83,2	88,1	103,3	124,1

HERMETIC MULTILED

INSTALLATION HEIGHT (meters)	DEL-60M	DEL-150M	DEL-200M	DEL-300M
2,0 m	10,74	17,98	20,73	36,22
2,5 m	14,32	22,77	24,50	40,68
3,0 m	21,11	25,44	29,68	42,10
3,5 m	19,35	30,97	35,81	48,63
4,0 m	15,52	34,12	43,98	53,47
4,5 m	11,34	42,88	47,50	61,35

SMART

INSTALLATION HEIGHT (meters)	SS-100L	SS-200L	SS-300L
2,0 m	14,45	31,90	43,98
2,5 m	15,08	36,19	49,76
3,0 m	16,23	38,45	57,58
3,5 m	13,57	39,52	68,89
4,0 m	10,14	41,78	71,87
4,5 m	5,34	42,88	73,26

EXTRAPLANA LED

INSTALLATION HEIGHT (meters)	FL-60	FL-150	FL-200	FL-300
2,0 m	21,64	24,63	33,49	40,71
2,5 m	22,90	26,42	36,31	47,78
3,0 m	24,63	30,19	38,48	55,41
3,5 m	23,75	32,16	39,59	63,61
4,0 m	22,06	31,16	43,01	69,39
4,5 m	21,23	29,21	44,17	72,38

EXTRAPLANA LED NON-MAINTAINED

INSTALLATION HEIGHT (meters)	F-80L	F-200L	F-300L	F-400L	F-500L
2,0 m	19,23	36,23	46,49	50,23	55,29
2,5 m	21,56	44,11	56,67	62,14	70,68
3,0 m	22,90	46,49	64,96	72,25	83,25
3,5 m	23,75	52,77	72,25	84,91	88,12
4,0 m	21,23	59,43	83,25	89,84	103,67
4,5 m	18,09	60,82	88,12	99,90	116,86

LISSA RECESSED

INSTALLATION HEIGHT (meters)	LNEL-300	LNL3-300
2,0 m	45,36	45,36
2,5 m	50,26	50,26
3,0 m	55,41	55,41
3,5 m	63,61	63,61
4,0 m	66,47	66,47
5,0 m	69,39	69,39

LISSA SURFACE

INSTALLATION HEIGHT (meters)	LNL-300	LNL3-300
2,0 m	45,36	45,36
2,5 m	50,26	50,26
3,0 m	55,41	55,41
3,5 m	63,61	63,61
4,0 m	66,47	66,47
5,0 m	69,39	69,39

BESSEL

INSTALLATION HEIGHT (meters)	L-60L	L-100L	L-150L	L-200L
2,0 m	13,85	22,86	25,51	37,28
2,5 m	16,61	24,63	33,17	41,71
3,0 m	18,09	25,51	37,38	46,89
3,5 m	15,20	28,24	38,48	49,89
4,0 m	12,56	26,42	39,58	52,77
4,5 m	7,08	23,75	38,23	54,09

EUROPRISMA

INSTALLATION HEIGHT (meters)	EH-200L	EH-300L
2,0 m	27,95	32,79
2,5 m	31,88	39,35
3,0 m	32,79	43,98
3,5 m	34,13	47,28
4,0 m	36,26	49,76
4,5 m	35,65	50,89



ROLUX LEUCHTEN GMBH
Margarete-Steiff-Straße 18
28844 Weyhe

TELEFON: 0421-696 791-0
FAX: 0421-696 791-1

HRB 207388
Amtsgericht Walsrode
USt-IdNr.: DE 114408089

www.rolux-leuchten.com

SIE ERREICHEN UNS

Montag bis Freitag
8.00 Uhr bis 16.00 Uhr

GESCHÄFTSFÜHRUNG

Herr Nie
light@rolux-leuchten.com

Dieser Katalog wurde mit größter Sorgfalt hergestellt. Alle technischen Angaben sind nach bestem Wissen ermittelt worden. Dennoch behalten wir uns Irrtümer und Druckfehler vor.

Die in diesem Katalog enthaltenen Artikel können jeder Zeit aus dem Sortiment genommen werden oder zu gunsten des technischen Fortschritts angepasst werden.

Wir haften nicht für eventuelle Nichtverfügbarkeit. Die Vervielfältigung der durch uns zur Verfügung gestellten Informationen, Daten, Bildern und Texten ist nicht gestattet und bedarf einer vorherigen Zustimmung.

Unsere Firma ist offizieller Partner von:

NORMALUX
by Normagrup

